



SILENT

We're The Vibrator Guys.™

**VIBCO**

[www.VIBCO.com](http://www.VIBCO.com)



## VIBRATION PRODUCTS

Established 1962

### THIS IS VIBCO

Qualified engineers, with over 40 years of experience in the vibrator field, assure you of the latest developments in vibration engineering. Well trained craftsmen put these developments into the most reliable and long lasting vibration equipment available today.

### OUR MOTTO

"ANOTHER FIRST BY VIBCO – QUALITY ENGINEERED PRODUCTS"

### FIRST:

First in the development of new products, first in using new techniques and materials, and first in following O.S.H.A. and ecology programs.

### U.S. PATENTS:

Most of VIBCO's products are manufactured under one or more of the following U.S. patents: 3.638.914; 3.672.639; 3.790.137; 3.870.282; 3.932.057; 3.938.905; 3.945.246; 4.042.102; 4.280.616; 4.389.120; 4.407.403; 4.583.414; 4.590.814; 4.653.927; 4.425.813; 5.143.256; 5.439.314; 5.672.027; 5.580.234.

These patents also applied for in most other countries.

### QUALITY ENGINEERED PRODUCTS:

The most complete and reliable line of vibration products available on the market today.

---

## FREE TRIAL

CONVINCE YOURSELF THAT OUR VIBRATOR WILL SOLVE  
YOUR VIBRATION PROBLEM AT

## NO RISK TO YOU

Ask for any one of our standard units for a **Free 10 Day Trial** to make sure the unit performs to **YOUR** satisfaction and does what **YOU** intended it to do. Your only obligation is to pay the Freight Charges.

To get your **FREE TRIAL UNIT** send us your purchase order marked "**FOR FREE TRIAL**" or call **1-800-633-0032**.

---

### OUR GUARANTEE IS VERY SIMPLE:



WE GUARANTEE OUR VIBRATORS TO PERFORM TO YOUR SATISFACTION OR THEY CAN BE RETURNED FOR FULL CREDIT OR EXCHANGED. We allow a 10 day trial at NO CHARGE to give you the opportunity to test the unit and make sure it does the job you intended it to do.

**ALL VIBCO's VIBRATORS ARE MADE IN THE U.S.**

---

**PHONE: 800-633-0032 • www.vibco.com • FAX: 401-539-2584**



We're The **SILENT** Vibrator Guys.™

and your **ONE** supply of **SILENT** Air and Electric Vibrators

## NOISE – HOW TO CONTROL IT

### VIBCO's SILENT TURBINE AIR VIBRATORS REPLACE NOISY BALL, ROLLER & PISTON VIBRATORS SIZE FOR SIZE

As a general rule for standard applications limit your selection of vibrators to the electric Model SCR adjustable speed and force vibrators (page 23 & 24) and the pneumatic silent turbine vibrators (page 3-12). These electric and pneumatic vibrators will give you the latest in vibration technology and design with the lowest noise, the best life, the least maintenance, and the lowest energy consumption.

## TABLE OF CONTENTS

<b>ELECTRIC</b>	<b>PAGE NO.</b>
<b>Model SCR</b> Adjustable speed and force vibrators	23-24
<b>Model 2P, 4P, 6P &amp; 8P</b> Electric - Heavy Duty vibrators offer 3600, 1800, 1200 & 900 RPM vibrators up to 10000 lbs force in 3 phase and up to 2000 lbs force in single phase. Available in both 60 & 50 cycles.	25-28
<b>Model SPR &amp; CE</b> - Small impact line open or totally enclosed and some water tight offers a small impact force for 115 or 230 volt 1 phase operation.	29-30
<b>Model US</b> - High Frequency line with frequencies up to 10000 VPM - A bin vibrator will easily move powdery materials like cement in weigh-batchers or consolidate concrete in septic tanks, man holes, forms, etc. (ask for catalog)	31-32
<b>Model DC</b> - 12 Volt battery operated vibrators ideal for mobile applications, the smaller units for screens & spreaders, the larger units & DC-3500 as dump body vibrators.	31-32
<b>Model PX</b> - Explosion proof in class 1 Group D & Class 2 Group F & G, Division 1 & 2.	33
<b>Model SFC</b> - End mounted in 3 phase & single phase, low cost heavy duty.	34
<b>Model FC</b> - Fan cooled for high ambient heat applications.	34
<b>PNEUMATIC</b>	
<b>Model BBS, FBS, VS, BVS, CC, MLT, MLTSS</b> - Silent Pneumatic Turbine	3-12
<b>Model BB, BV &amp; V</b> - Ball vibrators, simple design, will operate in temperatures up to 350 degrees F. Need lubrication.	13-14
<b>Model Piston Vibrators</b> - Low cost, powerful units, need lubrication & clean air. Linear force makes them ideal for screens & feeders, smaller units for foundry match plates. Many special designs like extended piston 50-EPS, single impacting LI models etc.	15-18
<b>Model SVRS</b> - High frequency and force up to 13000VPM with low dB reading 80-90, used on all types of precast, prestressed & concrete pipe forms. Many different brackets available for portable applications (see catalog), as railroad carshakers and bin vibrators for large bins with sticky materials.	19-20
<b>Model SVR</b> - Same as Model SVRS but without muffler making them noisier with a dB reading of 95-100. Lower cost than the SVRS units.	19-20
<b>Model PC, PF</b> - Typical use RR-car shakers, both as clamp on or fitting into dove tail brackets on the RR cars.	21-22
<b>HYDRAULIC</b>	
<b>Model LH</b> - Heavy duty, large bearings, long life, linear force for screen & feeder applications.	21-22
<b>Model HLF</b> - Low cost hydraulics for up to 1300 lbs of force.	21-22
<b>Model HF</b> - With forces up to 3500 lbs patented coupling between motor & vibrating unit increasing motor life & eliminating early motor failure.	21-22
<b>Model B</b> - Small size with force up to 600 lbs at 1000 PSI.	21-22

Note: For additional Vibco Products see pages 35-46. For additional selection data see pages 47-50.

Note: Dimensions & data subject to change without notice.

# “SILENT” Pneumatic

## BEST BY TEST

### DBA — NOISE — LIFE CURVE

Turbine vibrators maintain 70-75 db's throughout their entire life, as compared to sharp increases in noise levels of ball roller and piston type vibrators. Turbine sound levels actually reduce after a short “break-in” period and retain a constant low sound level throughout their life. Although ball and roller vibrators start at under OSHA limits, they quickly and steadily increase noise levels to well above OSHA, to beyond bearable range. (See curve.) This is caused by ball or roller jumping and accelerating each time it passes the air inlet, causing pitting and continuing wear to the ball and races.

A turbine vibrator outlasts a ball vibrator 3 to 1.

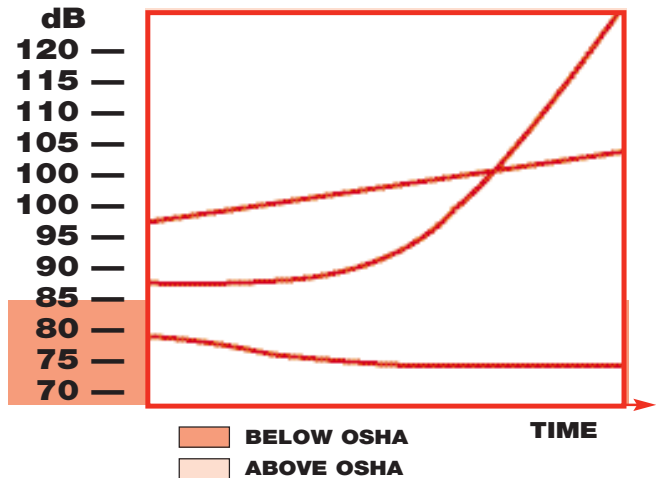

### WHY REPLACE A BALL VIBRATOR WITH A TURBINE VIBRATOR

1. NOISE — Average turbine as low as 72db.
2. ENERGY CONSUMPTION — Turbine takes less air, while air consumption steadily increases on a ball vibrator, it decreases in the turbine as the bearings are “broken in”.
3. LIFE — The effective life of the turbine far exceeds the life of a ball. See above dba — NOISE — LIFE CURVE.
4. EFFICIENCY — The turbine maintains its speed during its complete life. The ball unit starts to lose its speed and efficiency from the very start due to pitting of ball and ballrace. See above dba — NOISE — LIFE CURVE.
5. NO LUBRICATION — Bearings are sealed and prelubricated for life.

### WHERE TO USE

Because of their fool-proof operation and their lessening of noise in production areas, the Silent Air Turbine Vibrators have quickly become the specified and standard units for many industries and in many leading plants. Examples are: parts feeding on tracks and trays in the automotive industry; on batchers, supply hoppers and chutes of chemical and plastics production and packaging lines; and on foundry match-plates, shake-outs and sand hoppers.

Other typical uses include: screening, separating and sizing of both fine and coarse powdered materials: settling, compacting and leveling in packaging; orientation and feeding of parts. Also, unjamming caps, cans and jars; aiding or controlling flow of material thru hoppers, screens, chutes. Size for size and mount same as for ball units.

## LIFETIME WARRANTY AGAINST WORKMANSHIP & MANUFACTURING DEFECTS

# Turbine Vibrators

**A: SILENT TURBINE VIBRATORS USE 50% LESS AIR THAN COMPARABLE PNEUMATIC BALL VIBRATORS**

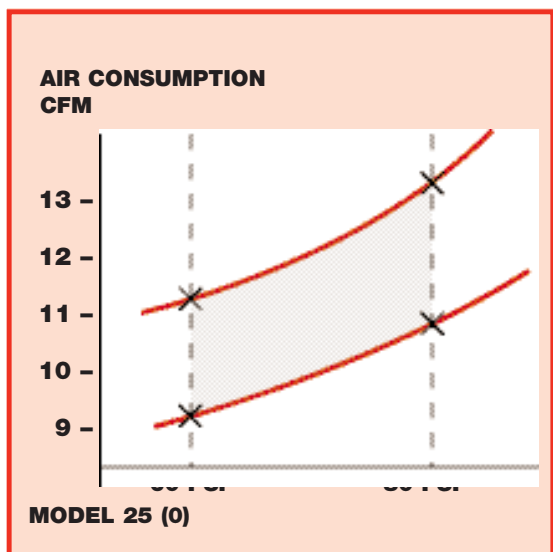

## AIR CONSUMPTION

A ball vibrator draws up to over 50% more air than a turbine vibrator. The ball in a ball vibrator takes up only 1/20 of available space in the housing and the majority of the air pushing the ball around in the ballrace is wasted and exhausted without producing any work. In a turbine vibrator, the turbine fits snugly in the housing and only a very minimal amount of air can escape without producing any work.

## EFFICIENCY

The turbine vibrator has a high level of efficiency throughout its life. Ball vibrators immediately lose speed and efficiency due to pitting of the ball and ballrace. An added plus to the turbine vibrator is that it is not subject to pitting and the turbine vibrator does not require airline lubrication like the ball vibrator.

## NOISE

Turbine vibrators maintain 70-75 dB throughout their entire life as compared to sharp increases in noise levels of ball, roller and piston vibrators, which can reach up to 100 dB or more.

**B: VIBCO SILENT TURBINE VIBRATORS CAN SAVE UP TO 56% OF THE AIR CONSUMPTION OF COMPETITIVE BALL VIBRATOR MODELS.**

See Chart Below

VIBCO TURBINE MODEL	CFM/ 60 PSI	COMPETITIVE BALL MODELS*	SAVED CFM BY USING VIBCO TURBINE VERSUS:**		
			MARTIN	COUGAR	GLOBAL
BVS & VS 100	4	6	11%	11%	56%
BVS & VS 130	4.5	13	40%	40%	70%
BVS & VS 160	7	16	N/A	N/A	14.6%
BVS & VS 190	7.5	19	32%	32%	37.5%
BVS & VS 250	8	25	38.5%	38.5%	55.5%
BVS & VS 320	9	32	47%	47%	44%
BVS & VS 380	16	38	20%	20%	36%
BVS & VS 440	18	44	14%	14%	48.5%
BVS & VS 510	18	51	N/A	20%	33%
BVS & VS 570	21	57	***54%	N/A	N/A

\*Covers ball vibrators

\*\*Values taken from published catalogs

\*\*\* Roller vibrator

# "SILENT" Pneumatic

## VS SERIES



**VS-510**



**VS-380**



**VS-320**



**VS-250**



**VS-190**



**VS-160**



**VS-130**



**VS-100**

### MODEL VS: BUILT-IN MUFFLER

Model VS Turbine Vibrators offer the feature of a BUILT-IN-MUFFLER. Ideal for rough applications or where moving machinery might damage external accessories. Eight sizes with forces up to 900 lbs. Popular for air material-conveying systems, medium size batch hoppers, etc. Available in both aluminum and malleable castings.

- Simple
- Built-In Muffler
- Totally Enclosed
- Continuous Duty
- Noiseless
- Maintenance Free
- Adjustable Speed
- Sturdy Cast Housings
- Heavy Duty Turbine Wheel



Ask for Catalog #9127

### TECHNICAL DATA

Model	Weight***		60 PSI		80 PSI					Max. Lbs. ** Material In Bin	
	lbs.	kg.	Speed VPM	CFM	Speed VPM	CFM	lbs.	Force	N		dB*
<b>VS-100</b>	7/13 oz.	.198/.368	12000	4			20		89	66	200
<b>VS-130</b>	11/21 oz.	.312/.595	8000	4.5	10500	5.5	75		334	67	750
<b>VS-160</b>	3	1.4	10000	7	12000	8	160		712	70	1600
<b>VS-190</b>	3.5	1.6	4200	7.5	7200	9	270		1201	70	5000
<b>VS-250</b>	5	2.3	5500	9	7200	10.5	500		2225	70	5000
<b>VS-320</b>	6.5	2.9	5200	9	6800	11	600		2669	69	7000
<b>VS-380</b>	11.5	5.2	4600	16	5200	17	725		3226	72	7250
<b>VS-510</b>	15	6.8	4000	18	4500	21	900		4004	77	9000

Data obtained on Laboratory test block. Frequency and force will decrease on less rigid mount. Note: Dimensions & data subject to change without notice.  
 \* Decibel from A-scale at 1 meter and 80 PSI. N = Centrifugal force in Newton.  
 \*\* Rule of thumb for sizing "One lb. Vibrator Force" to each 10 lbs. of Bin Content" at 80 PSI.  
 \*\*\* Fist Figure Aluminum 2nd - malleable iron.

Model	A		B		C**		L		W		H		D		E		F		G		I*		J		K	
	inch/mm	inch/mm	inch/mm	inch/mm	inch/mm	inch/mm	inch/mm	inch/mm	inch/mm	inch/mm	inch/mm	inch/mm	inch/mm	inch/mm	inch/mm	inch/mm	inch/mm	inch/mm	inch/mm	inch/mm	inch/mm	inch/mm	inch/mm	inch/mm	inch/mm	inch/mm
<b>VS-100</b>	3	76	-	-	1/4	6	3 3/8	98	1 7/8	48	2	51	3/4	19	3/8	10	1 5/16	33	1 11/16	43	1/8 - NPT	5/8	16	1	25	
<b>VS-130</b>	4	102	-	-	3/8	10	4 7/8	124	2	51	2 5/16	59	1 5/16	24	3/8	10	1 1/2	38	1 15/16	49	1/8 - NPT	3/4	19	1 1/4	32	
<b>VS-160</b>	4	102	-	-	3/8	10	5 1/8	130	2 7/8	73	3	76	1 7/16	37	1 1/16	17	1 1/8	48	2 1/16	62	1/4 - NPT	7/8	22	1 5/8	41	
<b>VS-190</b>	4	102	-	-	3/8	10	5 7/16	138	3 1/4	83	3 1/16	78	1 5/16	33	5/8	16	2 1/8	54	2 1/2	64	1/4 - NPT	7/8	22	1 3/4	44	
<b>VS-250</b>	4	102	-	-	1/2	13	5 1/2	140	3 5/8	92	3 11/16	94	1 1/2	38	9/16	14	2 1/4	57	3	76	1/4 - NPT	1 1/8	29	1 7/8	48	
<b>VS-320</b>	4	102	-	-	1/2	13	5 1/2	140	4	102	4 3/4	121	1 3/4	44	1 3/16	21	2 1/4	57	4 1/8	105	3/8 - NPT	1 1/4	32	2 3/4	70	
<b>VS-380</b>	5 1/2	140	1 1/4	32	3/8	10	6 7/8	175	4 3/4	121	4 7/8	124	2 1/4	57	1	25	2 7/8	73	4	102	3/8 - NPT	1 1/2	38	2 1/2	64	
<b>VS-510</b>	5 1/2	140	1 3/4	44	3/8	10	6 15/16	176	4 3/4	121	5 3/8	137	2 3/4	70	1	25	3 1/4	83	4 3/4	121	1/2 - NPT	1 3/4	44	2 7/8	73	

\*NPT Pipe Tap Size      \*\*Bolt Size

Note: Dimensions & data subject to change without notice.

# Turbine Vibrators

## BVS SERIES

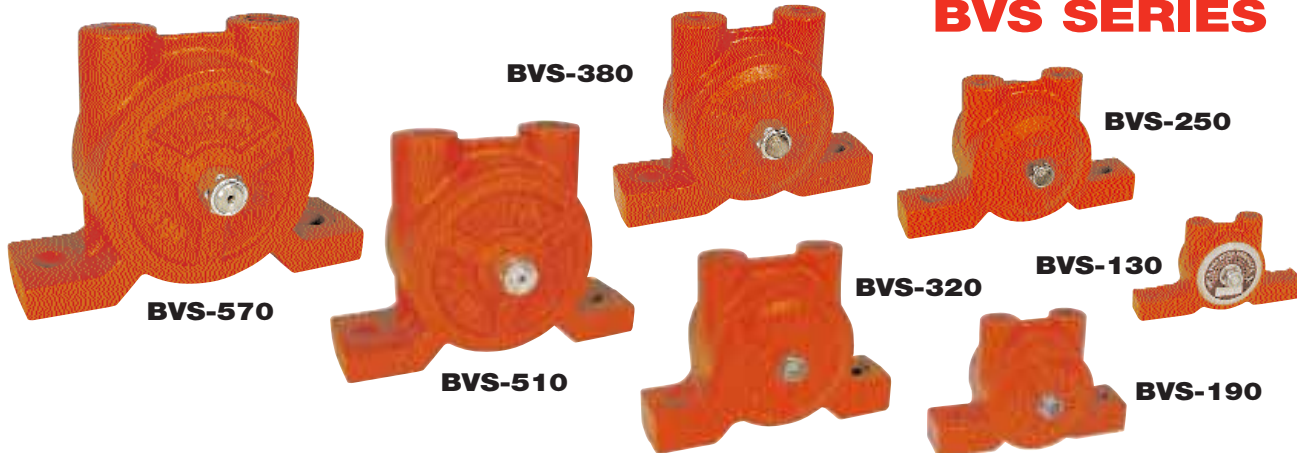

### MODEL BVS: THREADED EXHAUST

VIBCO offers 10 models in the extra heavy duty BVS series. The use of non-lubricated air supply makes the BVS turbine vibrators perfect for applications in food and pharmaceutical (etc.) industries where oil exhaust would be objectionable. Exhaust port is threaded for piping off of air exhaust in closed, sanitized systems. Extra large amplitudes and wide range of sizes makes the BVS's ideal for quickly moving parts or materials.

- Quiet, Meets OSHA As Low As 68 dB at 1 Meter
- No Lubrication Required
- Easily Repaired - One Moving Part
- Patented Design
- High Force Output
- Outlasts Piston Vibrators 3 to 1
- Oversized Bearings

### TECHNICAL DATA

Model	Weight***		60 PSI		80 PSI					Max. Lbs.** Material In Bin	
	lbs.	kg.	Speed VPM	CFM	Speed VPM	CFM	lbs.	Force	N*		dB*
BVS-60	7/13 oz.	.198/.368	12000	4			20		89	66	200
BVS-130	10/20 oz.	.283/.567	8000	4.5	10500	5.5	75		334	67	750
BVS-160	3	1.4	9500	7	11000	8	160		712	70	1600
BVS-190	3.5	1.6	5500	7.5	7200	8.5	270		1201	71	2700
BVS-250	6	2.7	5200	8	7200	9	480		2136	72	4800
BVS-320	8.5	3.9	5500	9	6800	10	600		2669	70	5300
BVS-380	13	5.8	4500	16	5000	18	670		2981	74	6700
BVS-440	16	7.3	4300	18	4800	21	700		3114	76	7000
BVS-510	16	7.3	4000	18	4500	21	900		4004	77	9000
BVS-570	23	10.4	3600	21	4000	26	1050		4671	83	10500

Data obtained on Laboratory test block. Frequency and force will decrease on less rigid mount. Data subject to design changes.

\* Decibel from A-scale at 1 meter and 80 PSI. N = Centrifugal force in Newton.

\*\* Rule of thumb for sizing "One lb. Vibrator Force" to each 10 lbs. of Bin Content" at 80 PSI.

\*\*\* Fist Figure Aluminum 2nd - malleable iron.

Model	A		C**		L		W		H		D		E		F		G		I*		J*	
	inch/mm	inch/mm	inch/mm	inch/mm	inch/mm	inch/mm	inch/mm	inch/mm	inch/mm	inch/mm	inch/mm	inch/mm	inch/mm	inch/mm	inch/mm	inch/mm	inch/mm	inch/mm	inch/mm	inch/mm	inch/mm	
BVS-60	3	76	1/4	6	3 <sup>13</sup> / <sub>16</sub>	97	1 <sup>5</sup> / <sub>8</sub>	41	2 <sup>7</sup> / <sub>16</sub>	62	3/4	19	5/8	16	1 <sup>3</sup> / <sub>16</sub>	30	1 <sup>1</sup> / <sub>4</sub>	32	1/8 - NPT	1/8 - NPT		
BVS-130	4	102	3/8	10	4 <sup>7</sup> / <sub>8</sub>	124	1 <sup>7</sup> / <sub>8</sub>	48	2 <sup>5</sup> / <sub>8</sub>	67	7/8	22	5/8	16	1 <sup>1</sup> / <sub>16</sub>	43	1 <sup>7</sup> / <sub>8</sub>	48	1/8 - NPT	1/4 - NPT		
BVS-160	4	102	3/8	10	5 <sup>1</sup> / <sub>2</sub>	140	2 <sup>7</sup> / <sub>8</sub>	73	3 <sup>5</sup> / <sub>8</sub>	92	1 <sup>3</sup> / <sub>8</sub>	35	9/16	14	1 <sup>11</sup> / <sub>16</sub>	43	1 <sup>7</sup> / <sub>8</sub>	48	1/4 - NPT	3/8 - NPT		
BVS-190	4	102	3/8	10	5 <sup>1</sup> / <sub>4</sub>	133	3 <sup>3</sup> / <sub>16</sub>	81	3 <sup>7</sup> / <sub>16</sub>	87	1 <sup>5</sup> / <sub>16</sub>	33	7/8	22	1 <sup>9</sup> / <sub>16</sub>	40	1 <sup>7</sup> / <sub>8</sub>	48	1/4 - NPT	3/8 - NPT		
BVS-250	5	127	1/2	13	6 <sup>3</sup> / <sub>4</sub>	171	3 <sup>9</sup> / <sub>16</sub>	90	3 <sup>15</sup> / <sub>16</sub>	100	1 <sup>5</sup> / <sub>8</sub>	41	7/8	22	1 <sup>7</sup> / <sub>8</sub>	48	2 <sup>5</sup> / <sub>16</sub>	59	1/4 - NPT	3/8 - NPT		
BVS-320	5	127	1/2	13	6 <sup>3</sup> / <sub>4</sub>	171	4	102	4 <sup>7</sup> / <sub>8</sub>	124	1 <sup>5</sup> / <sub>8</sub>	41	1 <sup>1</sup> / <sub>8</sub>	29	2 <sup>1</sup> / <sub>4</sub>	57	2 <sup>3</sup> / <sub>4</sub>	70	3/8 - NPT	1/2 - NPT		
BVS-380	6	152	5/8	16	7 <sup>15</sup> / <sub>16</sub>	202	4 <sup>3</sup> / <sub>4</sub>	121	5 <sup>13</sup> / <sub>16</sub>	148	2	51	1 <sup>1</sup> / <sub>8</sub>	29	2 <sup>11</sup> / <sub>16</sub>	68	3	76	3/8 - NPT	1/2 - NPT		
BVS-440	7	178	5/8	16	8 <sup>15</sup> / <sub>16</sub>	227	4 <sup>3</sup> / <sub>4</sub>	121	5 <sup>3</sup> / <sub>4</sub>	146	2 <sup>3</sup> / <sub>16</sub>	56	1 <sup>3</sup> / <sub>16</sub>	30	2 <sup>7</sup> / <sub>16</sub>	62	3 <sup>7</sup> / <sub>16</sub>	87	1/2 - NPT	3/4 - NPT		
BVS-510	7	178	5/8	16	8 <sup>15</sup> / <sub>16</sub>	227	4 <sup>3</sup> / <sub>4</sub>	121	5 <sup>3</sup> / <sub>4</sub>	146	2 <sup>1</sup> / <sub>4</sub>	57	1 <sup>1</sup> / <sub>4</sub>	32	2 <sup>9</sup> / <sub>16</sub>	65	3 <sup>7</sup> / <sub>16</sub>	87	1/2 - NPT	3/4 - NPT		
BVS-570	8	203	3/4	19	10 <sup>3</sup> / <sub>16</sub>	259	5 <sup>7</sup> / <sub>16</sub>	138	7 <sup>1</sup> / <sub>4</sub>	184	2 <sup>15</sup> / <sub>16</sub>	75	1	25	3 <sup>3</sup> / <sub>8</sub>	79	4	102	3/4 - NPT	1 - NPT		

\*NPT Pipe Tap Size \*\*Bolt Size

Note: Dimensions & data subject to change without notice.

# “SILENT”

# Pneumatic

## SANITARY MLT SERIES



**MLT-320  
MHI-320**



**MLT-250  
MHI-250**



**MLT-190  
MHI-190**



**MLT-130  
MHI-130**



**MLTSS-130  
MHISS-130**



**MLTSS-130  
MHISS-130**



**MLTSS-320  
MHISS-320**

## MODEL MLT & MHI SANITARY TURBINE

- **IDEAL FOR SANITARY APPLICATIONS EVEN IN HARSH CHEMICAL ENVIRONMENTS**
- **MANY DIFFERENT SANITARY FINISHES AVAILABLE**

The NEW Millennium Line of Sanitary Pneumatic Turbine (MLT/MHI) Vibrators is your solution for all sterile/clean applications. The line consists of the MLT & MHI-130, -190, -250 and 320; all are designed for the most adverse applications. Their extruded aluminum housings, stainless steel shafts, and aircraft aluminum covers, give these vibrators additional strength, durability and long life. They are also designed with slotted mounting holes for easy installation on many bolt patterns and tapped exhaust ports that allow exhausting air to be piped off to insure a clean environment. These units can be supplied with a variety of sanitary finishes such as: high gloss dairy white industrial enamel, anodized or unpainted aluminum.

Ideal for applications in industries that require a sanitary vibrator. Such industries include: food, beverage, and pharmaceutical industries.

Model MLT-250, as part of the millennium Turbine Line of Vibrators has high speed sealed bearings that are pre-lubricated for life making them maintenance free. They have an operating range of 30-80 PSI and a maximum operating temperature of 250°F or 120°C. Decibel readings well below OSHA limits, as low as 68dB on A-scale at 1 meter with no more sound than an electric motor. The patented millennium turbine vibrator draws 50% less air than a comparable ball vibrator and lasts three times longer. Like the rest of VIBCO's products these are 100% made in the USA and competitively priced.

The MLT & MLTSS are designed for continuous duty at up to 80 PSI and have heavy duty bearings for long life.

The MHI & MHISS Lines are designed to produce high frequency and maximum forces. Intermittent duty only. (30 seconds max. continuous running. Running time equal to or less than off time.)

## MODEL MLTSS & MHISS STAINLESS STEEL

- **CONSTRUCTED OF 303 STAINLESS STEEL**
- **COMPLETELY MADE IN USA WITH VIBCO's PATENTED DESIGN**

**MODEL MLTSS & MHISS** -130, -190, -320 – Stainless Steel Pneumatic Turbine Vibrators are constructed of 303 Stainless, specifically made for any sanitary application found in the pharmaceutical, food and beverage or other caustic chemical type environments, like the plating industry. The **MLTSS & MHI** vibrators are totally enclosed and wash down safe. No lubrication is necessary as the bearings are pre-lubricated for life, making them maintenance FREE. Exhausting air can either be muffled or ported to an outside location preserving a sanitary environment.

Advantages of the **MLTSS & MHISS** line of sanitary vibrators include:

- Non-corroding housing
- Wash down safe clean flat surface makes for easy wipe down
- Lowest noise levels in the industry, no more sound than an electric motor 68-75 dB
- Air consumption at 50% less than comparable ball vibrators
- 100% made in the USA, ships from **STOCK**

Operating pressure is 30-80 PSI with a maximum operating temperature of 250F or 120C.



# Turbine Vibrators

## STAINLESS STEEL AND MLT SERIES

### TECHNICAL HIGHLIGHTS

- Pressure range 30 to 80 PSI
- Operating temp. max 250°F, 120°C
- Decibel level as low as 68 dB on A-scale at 1 meter
- Air consumption 50% less than comparable ball vibrators
- Bearings are prelubricated for life

### TECHNICAL DATA

MODEL	WEIGHT		60 PSI***				80 PSI***				dB****
	lbs.	kg.	Speed VPM*	CFM	Force (lbs.)	Force(N)	Speed VPM*	CFM	Force (lbs.)	Force (N)	
MLT-130 MLTSS-130	1 2	.45 .9	8600	4.5	50	225	10500	5.5	75	334	68
MLT-190 MLTSS-190	2 7	.91 3.2	5500	7.5	160	710	7200	8.5	270	1200	71
MLT-250	2.4	1.08	5200	8	250	1115	7200	9	480	2136	72
MLT-320 MLTSS-320	4.5 13	2.04 6.0	5500	9	390	1740	6800	10	600	2669	70
MHI-130 MHISS-130	1 2	.45 .9	17200	4.5	200	890	21000	5.5	300	1340	68
MHI-190 MHISS-190	2 7	.91 3.2	8000	7.5	335	1490	10500	8.5	575	2560	71
MHI-250	2.4	1.08	7400	8	510	2270	10200	9	965	9290	72
MHI-320 MHISS-320	4.5 13	2.04 6.0	7200	9	675	3000	10000	10	1300	5780	70

\* Vibrations per minute N = Centrifugal force in Newtons

\*\*\* Test data are close to actual performance data of the unit on a typical application. The data obtained on a heavy laboratory test block cannot be duplicated on a typical application. We feel it is more important for the customer to measure the actual frequency of the unit on the application and know the unit is performing to specifications than not knowing what performance path to expect, or worse believing the test block data should be obtained.

\*\*\*\*Decibel from A-scale at 1 meter and 80 PSI Note: Dimensions & data subject to change without notice.

### DIMENSIONS

	A		C*		L		W		H		D		E		F		G		I	J
	inch/mm		inch/mm		inch/mm		inch/mm		inch/mm		inch/mm	inch/mm		inch/mm		inch/mm		inch/mm	Inlet	Outlet
MLT-130 & MHI-130	2-3/4	70	1/4	6	3-1/2	89	1-7/8	48	2-1/2	64	1	25	1/2	13	1-1/8	29	1-7/16	37	1/8-NPT	1/4 NPT
MLT-190 & MHI-190	3-1/2	89	3/8	10	4-1/2	114	3-3/8	86	3-3/16	81	1-13/16	46	5/8	16	1-1/2	38	1-15/16	49	1/4-NPT	3/8-NPT
MLT-250 & MHI-250	4	102	3/8	10	5	127	3-1/2	89	3-3/8	86	2	51	5/8	16	1-11/16	43	2-1/4	57	1/4 NPT	3/8-NPT
MLT-320 & MHI-320	5	127	1/2	13	6-3/8	162	4	102	4-1/4	108	2	51	13/16	21	2-1/16	52	2-13/16	71	3/8-NPT	1/2-NPT
MLTSS-130 & MHISS-130	2-3/4	70	1/4	6	3-1/2	89	1-7/8	48	2-1/2	64	1	25	1/2	13	1-3/16	29	1-7/16	37	1/8-NPT	1/4 NPT
MLTSS-190 & MHISS-190	3-1/2	89	3/8	10	4-1/2	114	3-3/8	86	3-3/16	81	1-13/16	46	5/8	16	1-3/4	38	1-15/16	49	1/4 NPT	3/8-NPT
MLTSS-320 & MHISS-320	5	127	1/2	13	6	152	4	102	4-1/4	108	2	51	13/16	21	2-1/8	52	2-13/16	71	3/8-NPT	1/2-NPT

\*Bolt Size Note: Dimensions & data subject to change without notice.

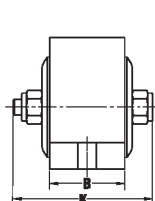

MLT/MHI

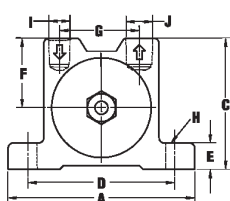

MLTSS/MHISS

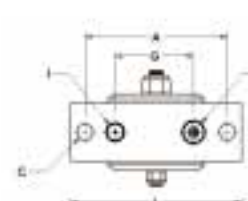
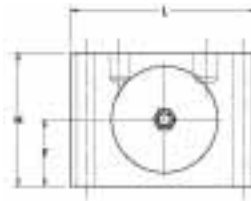
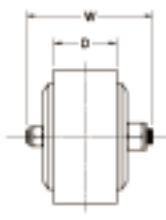

# “SILENT” Pneumatic

## CC SERIES



**CCF-2000  
CCF-4000**



**CCF-5000  
CCF-7000**

**CCL-2000  
CCL-4000**  
Use LC-2  
bracket



**CCL-7000  
CCL-5000**  
Use LC-1  
bracket



LUG BRACKET  
FOR

## MODEL CC HEAVY DUTY

- QUIET
- MEETS OSHA STANDARDS
- NO LUBRICATION REQUIRED

The only unit on the market to offer high force and absolutely quiet operation. Six units available. They all work on the **patented turbine principle**. Compressed air drives a specially designed turbine wheel, allowing the air to be channeled through the unit, then exhausting through muffler pads, making them virtually noiseless. None of these units need lubrication, all are prelubricated for life. Oversized bearings give the units years of trouble-free service.

### MODEL CCF-2000 & -4000, CCF-5000 & -7000

The quiet solution for large bins, hoppers and chutes. Ideal for the packing table and screen applications. The lightweight and high force output, CCF-2000 with 2,000 lbs. of force and CCF-5000 with 5,000 lbs. of force, replaces noisy 3 and 4" piston vibrators. The CCF-7000 with 7000 lbs. of force, 7200 VPM and 78dB is ideal for precast and prestressed concrete and replaces noisy roller vibrators with 100-110 dB.

### MODEL CCW-2000 & 4000

For portable applications CCW-2000 comes with either a 2" or 3" wide wedge. The 2" wedge is used on septic tanks, man holes, columns, portable hoppers and tote bins. The 3" wedge is used for larger forms such as wall and utility vaults, etc.

- EASILY REPAIRED IN THE FIELD
- PATENTED DESIGN

### MODEL CCW-5000

CCW-5000 the Quiet Railroad Carshaker, has in the last few years replaced the noisy piston railroad carshakers. Not only are they quiet, they need no lubrication and outlast the piston 3 to 1. Replaces 3" & 4" piston vibrators.

### MODEL CCL-2000, -4000, -5000 & -7000

The portable CCL-2000 uses the LC-2 lug bracket. Its light weight makes it ideal for all small concrete precast forms. Model CCL-5000 with its 75dB rating is ideal for tables, casting concrete panels, window frames, etc. or replacing large piston vibrators 4" and up on large bins. CCL-7000 with its special turbine wheel for below OSHA operation, only 78dB and high force 7000 lbs. and 7200 VPM, is now replacing the noisy 100-110dB roller vibrators in the concrete pipe, prestressed and precast industries. No lubrication is necessary. The oversized prelubricated bearings assure a long and maintenance free life.

### MODEL VSP-510

VSP-510 - A silent unit for concrete burial vaults, etc. as well as other applications where the vibrator is moved from form to form or bin to bin. They meet OSHA standards for being completely noiseless, never need lubrication and outlast standard pistons three to one.

Dimensions: 7"L x 4"W x 8"H

Pin Diameter: 1" - Fits into UPF female bracket.

# Turbine Vibrators



**CCW-5000 RAILROAD CARSHAKER**

**Female Brackets**



**UWF-1** for 2" Wedge  
**UWF-3** for 3" Wedge



**CCW-2000**  
2" Wedge  
**CCW-4000**  
3" Wedge

**HEAVY DUTY SERIES**



**VSP-510**    **UPF**

**TECHNICAL DATA**

Model	Weight		60 PSI		80 PSI			Force lbs.	N*	dB*	Max. Lbs.** Material in Bin
	lbs.	kg.	Speed VPM	CFM	Speed VPM	CFM					
<b>CCF, CCL &amp; CCW-2000</b>	23	10.5	4000	30	6000	40	2000	8998	78	20000	
<b>CCF, CCL &amp; CCW-4000</b>	23	10.5	4000	30	6000	40	4000	17996	78	40000	
<b>CCF &amp; CCL-5000</b>	48	21.8	4000	35	6000	50	5000	22245	75	50000	
<b>CCW-5000</b>	48	21.8	5000	40	7200	50	7000	31143	78	70000	
<b>CCF &amp; CCL-7000</b>	48	21.8	5000	40	7200	50	7000	31143	78	70000	
<b>VSP-510</b>	15	6.8	4000	18	4500	21	1000	4004	77	9000	

Data obtained on Laboratory test block. Frequency and force will decrease on less rigid mount. Note: Dimensions & data subject to change without notice.  
\* Decibel from A-scale at 1 meter and 80 PSI. N = Centrifugal force in Newton.  
\*\* Rule of thumb for sizing "One lb. Vibrator Force" to each 10 lbs. of Bin Content" at 80 PSI.

**DIMENSIONS**

Model	A	C**	L	W	H	D	E	F	G	I*	J*	K	M
	inch/mm	inch/mm	inch/mm	inch/mm	inch/mm	inch/mm	inch/mm	inch/mm	inch/mm	inch/mm	inch/mm	inch/mm	inch/mm
<b>CCF-2000&amp;4000</b>	6 152	5/8 16	7 1/2 191	8 1/16 205	7 1/8 181	5 1/16 129	3/4 19	5/8 137	1 3/4 44	3/4 - NPT	-	-	2 51
<b>CCL-2000&amp;4000</b>	-	-	7 178	8 1/16 205	7 1/4 184	5 1/16 129	3/8 10	3/4 19	4 1/8 105	3/4 - NPT	-	6 152	-
<b>CCW-2000</b>	-	-	7 178	8 1/16 205	8 203	5 1/16 129	7/8 22	2 1/4 57	5 5/16 151	3/4 - NPT	-	-	-
<b>CCW-4000</b>	-	-	7 178	8 1/16 205	8 203	5 1/16 129	7/8 22	3 1/8 79	5 5/16 151	3/4 - NPT	-	-	-
<b>CCF-5000&amp;7000</b>	8 203	3/4 19	10 1/4 260	8 5/8 219	8 7/8 225	6 1/16 154	1 1/8 29	6 1/4 159	2 7/8 73	1 - NPT	-	-	3 1/8 79
<b>CCL-5000&amp;7000</b>	-	-	9 3/8 238	8 5/8 219	8 5/8 219	6 1/16 154	1 3/16 21	1 1/4 32	5 1/4 133	1 - NPT	-	8 203	-
<b>CCW-5000</b>	-	-	9 3/4 248	8 5/8 219	8 5/8 219	6 1/16 154	1 1/8 29	5 1/2 140	4 5/8 117	1 - NPT	3/4 - NPT	-	-

\*NPT Pipe Tap Size    \*\*Bolt Size    Note: Dimensions & data subject to change without notice.

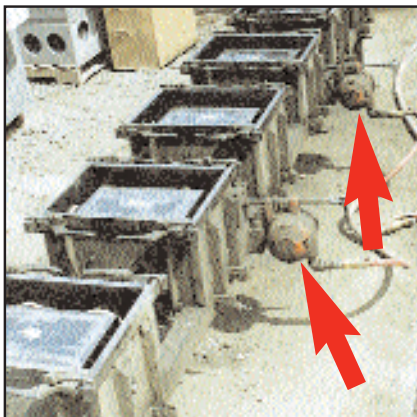
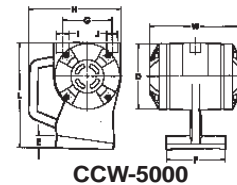
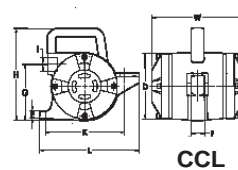
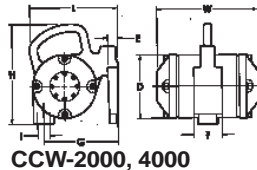
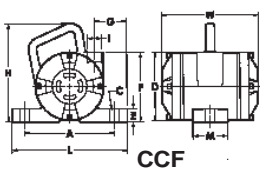

CCW-2000 on distribution boxes

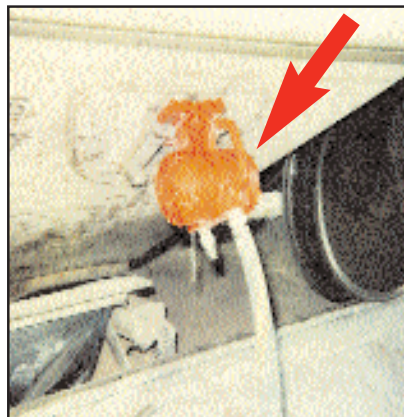

CCW-5000 railroad car shaker



VSP-510 on burial vault forms

**“SILENT”**

# Pneumatic Vibrators

## BBS SERIES

## FBS SERIES



**BBS-160**  
**BBS-190**



**BBS-130**



**BBS-100**



**FBS-160**  
**FBS-190**



**FBS-130**



**FBS-100**

## MODEL BBS & FBS

BBS-100, 130, 160 and 190 - smallest of VIBCO turbine vibrators; with versatile mount and aluminum\* housing. Never needs oil for continuous duty operation. The FBS-100, 130, 160 and 190 are designed especially

as a match plate vibrator for the foundry industry. For fast start, high RPM and force and low noise with a built-in muffler. The match plate vibrators to be used only for intermittent duty.

\*Malleable casting available on special order.

## TECHNICAL DATA

Model	Weight***		60 PSI		80 PSI					Max. Lbs.** Material In Bin
	lbs.	kg.	Speed VPM	CFM	Speed VPM	CFM	lbs.	Force N	dB*	
<b>BBS-100</b>	5 oz.	.142	12000	3.5			20	89	66	200
<b>BBS-130</b>	9 oz.	.255	8000	4.5	10500	5.5	75	334	67	750
<b>BBS-160</b>	12 oz.	.340	5500	5	9000	7	160	712	67	1600
<b>BBS-190</b>	15 oz.	.425	8500	5	10000	7	250	1112	70	2500
<b>FBS-100</b>	10.5 oz.	.298	15000	5			30	133	66	For Match-Plates
<b>FBS-130</b>	16 oz.	.454	13000	6	15000	7	150	667	68	For Match-Plates
<b>FBS-160</b>	24 oz.	.680	10500	6	13000	7	225	1001	68	For Match-Plates
<b>FBS-190</b>	26 oz.	.737	8500	6	10000	8	250	1112	70	For Match-Plates

Data obtained on Laboratory test block. Frequency and force will decrease on less rigid mount.

Note: Dimensions & data subject to change without notice.

\* Decibel from A-scale at 1 meter and 80 PSI. N = Centrifugal force in Newton.

\*\* Rule of thumb for sizing "One lb. Vibrator Force" to each 10 lbs. of Bin Content" at 80 PSI.

Model	A		C**		L	W		H	D	E		G	I*				
	inch/mm	inch/mm	inch/mm	inch/mm	inch/mm	inch/mm	inch/mm	inch/mm	inch/mm	inch/mm	inch/mm	inch/mm	inch/mm				
<b>BBS-100</b>	2 <sup>5</sup> / <sub>8</sub>	67	5 <sup>1</sup> / <sub>16</sub>	8	3 <sup>3</sup> / <sub>4</sub>	83	1 <sup>5</sup> / <sub>8</sub>	41	2	51	1	25	5 <sup>1</sup> / <sub>16</sub>	8	9 <sup>1</sup> / <sub>16</sub>	14	1/8 - NPT
<b>FBS-100</b>																	
<b>BBS-130</b>	3 <sup>3</sup> / <sub>16</sub>	81	3 <sup>3</sup> / <sub>8</sub>	10	3 <sup>3</sup> / <sub>4</sub>	95	1 <sup>7</sup> / <sub>8</sub>	48	2 <sup>1</sup> / <sub>4</sub>	57	1 <sup>3</sup> / <sub>16</sub>	30	5 <sup>1</sup> / <sub>16</sub>	8	5 <sup>5</sup> / <sub>8</sub>	16	1/4 - NPT
<b>FBS-130</b>																	
<b>BBS-160&amp;190</b>	3 <sup>9</sup> / <sub>16</sub>	90	3 <sup>3</sup> / <sub>8</sub>	10	4 <sup>1</sup> / <sub>8</sub>	105	2	51	2 <sup>9</sup> / <sub>16</sub>	65	1 <sup>1</sup> / <sub>4</sub>	32	5 <sup>1</sup> / <sub>16</sub>	8	3 <sup>3</sup> / <sub>4</sub>	19	1/4 - NPT
<b>FBS-160&amp;190</b>																	

## DIMENSIONS

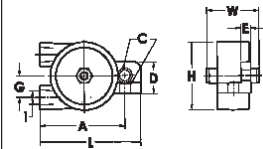

\*NPT Pipe Tap Size

\*\*Bolt Size

Note: Dimensions & data subject to change without notice.

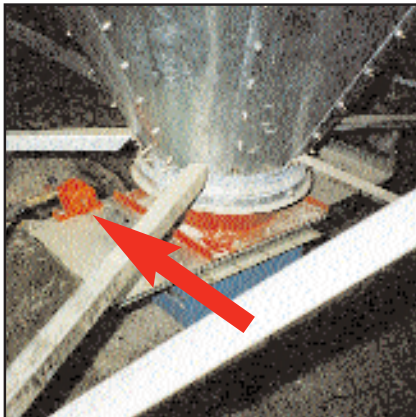

VS-250 on transfer chute

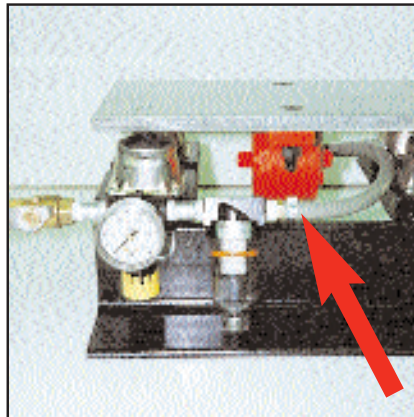

VS-190 on test table

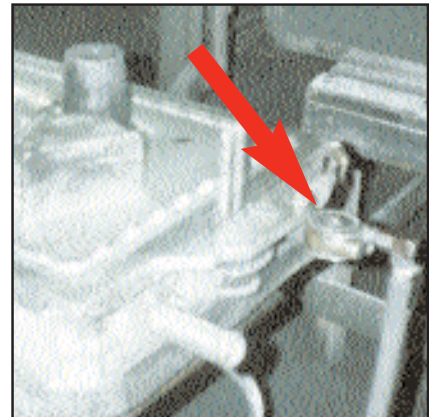

FBS-190 on molding machine

# "SILENT" Turbine Vibrators In Action

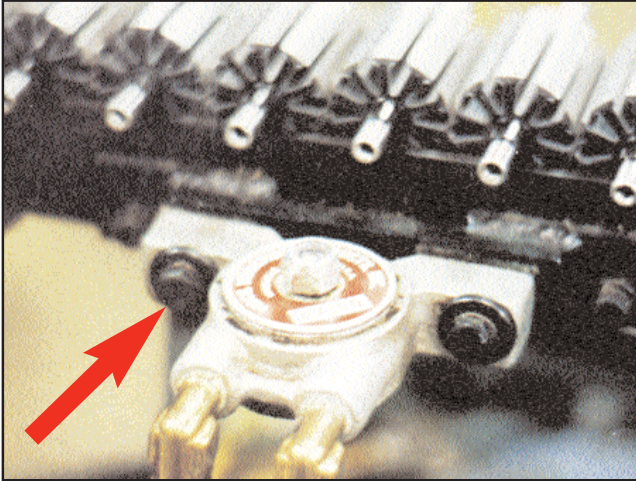

Small SILENT Turbine mounted to automated parts alignment track. Helps keep parts moving freely.

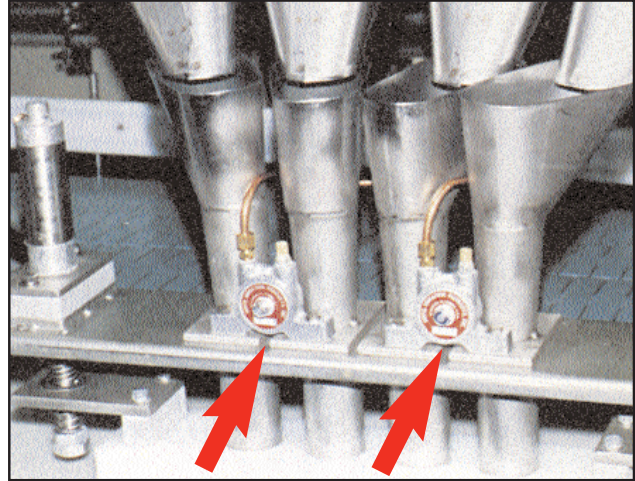

SILENT Turbines mounted on a track to consolidate pills in bottles while filling.

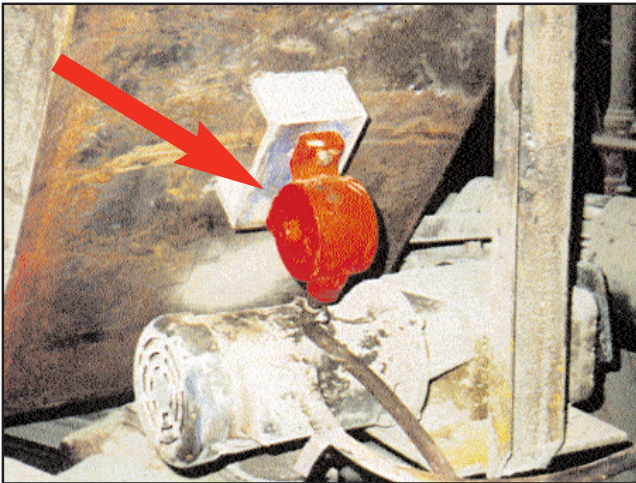

SILENT Turbine mounted to a fly ash chute to keep ash flowing.

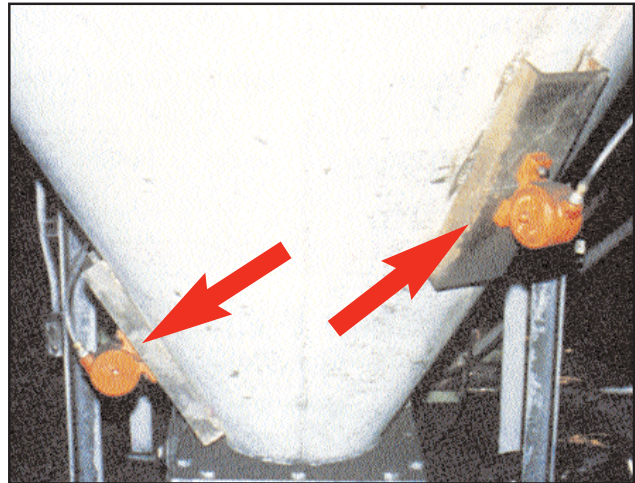

Two SILENT Turbines on a bin with chemicals to help stop bridging.

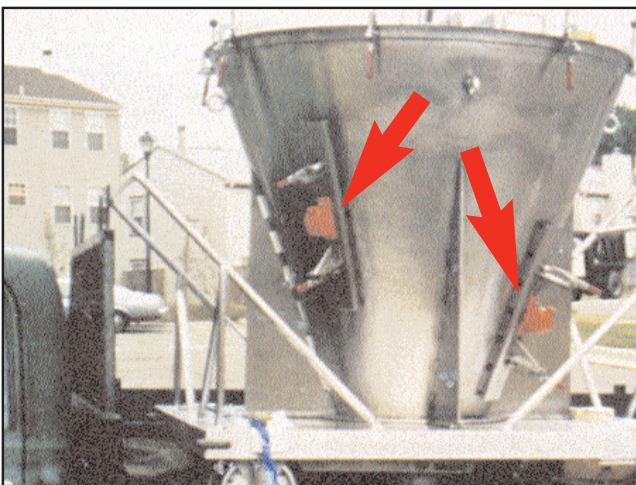

Two small SILENT Turbines mounted to cement hopper.

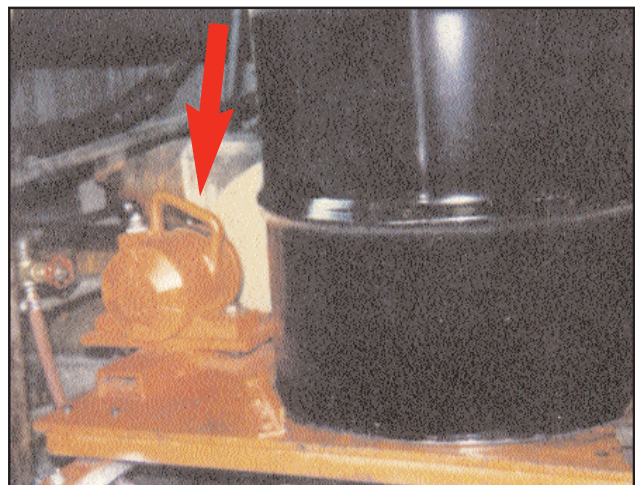

Big SILENT Turbine on a table to insure full capacity packaging of 55 gallon drums.

# Pneumatic Ball

## MODEL BB



**BB-100**



**BB-160**



**BB-130**



**BB-190**

## MODEL V



**V-100**



**V-190**



**V-130**



**V-250**



**V-320**



**V-380**

## MODEL BV



**BV-60**



**BV-190**



**BV-320**



**BV-130**



**BV-250**



**BV-380**

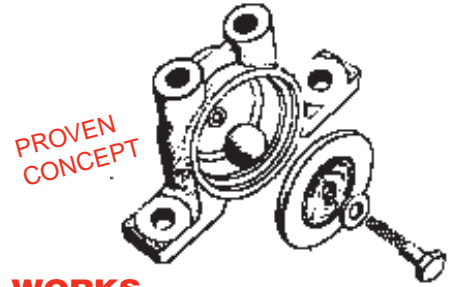

## HOW IT WORKS

Compressed air drives a hardened steel ball at high speeds around a highly finished and hardened steel race creating high frequency vibration. VIBCO BALL VIBRATORS require lubrication for long maintenance-free operation, start in any position. Mount VIBCO BALL VIBRATOR either directly to structure to be vibrated, or use simple mounting plates welded or bolted to the structure for better vibration transfer to a larger surface.

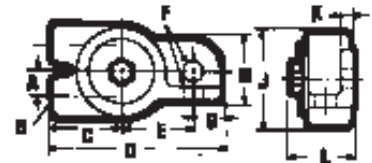

## MODEL BB

The BB Series can be equipped with a muffler on the threaded exhaust port. The threaded exhaust also allows oily exhaust air to be piped away from the area of operation if absolute cleanliness is required. These dual mount vibrators are designed for applications requiring a small to medium amount of vibration such as laboratory equipment, small hoppers, part feeders, chutes and match plates.

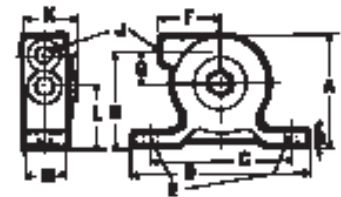

## MODEL V

The V-line ball vibrators are the most versatile units. Lowest in cost, light and sturdy, they're made to work in adverse conditions of water, heat, cold or dirt, and in any position. The most versatile and popular unit is the V-320 considered the work horse of the line producing 600 lbs. at 10,000 VPM. Models V-100 & V-130 have built-in exhaust mufflers. All other models have threaded exhaust ports. For units with built-in mufflers, order V-19SE, V-25SE, V-35SE, OR V41SE

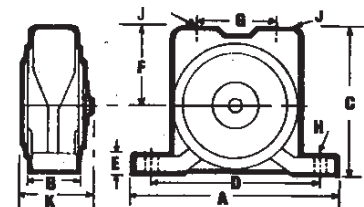

## MODEL BV

The BV Series like the others requires lubrication. Will withstand continuous operation at high temperatures up to 350° by maintaining a constant low air pressure of 5 to 10 PSI through unit when not in operation. The easily exchangeable ball races make them easy to repair for prolonged life at a small cost. The top air outlet port allows discharged air to be silenced by a muffler, or piped away from the area of operation if absolute cleanliness is required.

# Vibrators

- **SIMPLE**
- **BUILT-IN-MUFFLER**
- **REMOVABLE RACE FOR EASY MAINTENANCE**
- **HIGH TEMPERATURE OPERATION**

## TECHNICAL DATA

Model	Weight		20 PSI		40 PSI		60 PSI		lbs.	Force N	dB*/VPM	Max. Lbs. ** Material In Bin
	lbs.	kg.	Speed VPM	CFM	Speed VPM	CFM	Speed VPM	CFM				
BB-100	8 oz.	.227	17000	2	20000	4	24000	6	55	245	75/20000	550
BB-130	10 oz	.283	12000	2.5	15000	5	19000	7.5	80	356	72/15000	800
BB-160	16 oz.	.454	11000	3	13000	6	15000	8	140	623	76/13000	1400
BB-190	18 oz.	.510	10000	4	12000	7	15500	11	250	1112	77/12000	2500
BV-60	8 oz.	.227	17000	2	20000	4	24000	6	55	245	75/20000	550
BV-130	11 oz	.312	12000	2	15000	5	19000	7.5	80	356	76/15000	800
			40 PSI		60 PSI		80 PSI					
BV-190	24 oz.	.689	12000	6	14000	10	16000	11	260	1157	77/12000	2600
BV-250	2.8	1.3	9200	8	10500	11	11000	13	380	1691	79/9200	3800
BV-320	4.8	2.2	6500	9	7500	14	8400	17	480	2136	80/6500	4800
BV-380	6.2	2.8	5500	10	6200	15	6500	20	600	2669	82/5500	6000
V-100	8 oz.	.227	20000	4	24000	6	-	-	55	245	75/20000	550
V-130	11 oz	.312	15000	5	19000	7.5	-	-	80	356	72/15000	800
V-190	26 oz.	.737	12000	6	14000	10	16000	11	260	1157	73/16000	2600
V-250	2.6	1.2	9200	8	10500	11	11000	13	380	1691	72/11000	3800
V-320	4.6	2.1	7500	12	8900	14	10000	17	650	2892	78/10000	6500
V-380	6.2	2.8	5500	10	6200	15	6500	20	600	2669	78/6500	6000

\* Data obtained on Laboratory test block. Frequency and force will decrease on less rigid mount.

\*\* Decibel from A-scale at 1 meter. N = Centrifugal force in Newton.

\*\* Rule of thumb for sizing "One lb. Vibrator Force" to each 10 lbs. of "Bin Content" at 80 PSI.

Note: Dimensions & data subject to change without notice.

## DIMENSIONS

MODEL	A inch/mm	B* inch	C inch/mm	D inch/mm	E inch/mm	F** inch/mm	G inch/mm	H inch/mm	J inch/mm	K inch/mm	L inch/mm
BB-100	9/16 14	1/8-NPT	1 1/4 32	3 1/4 83	1 3/8 35	5/16 8	1/2 12	1 25	2 51	5/16 8	1 9/16 40
BB-130	5/8 16	1/4-NPT	1 5/8 41	3 3/4 95	1 9/16 40	3/8 10	9/16 14	1 3/16 30	2 1/4 57	5/16 8	1 15/16 49
BB-160	3/4 19	1/4-NPT	1 3/4 44	4 1/8 105	1 13/16 46	3/8 10	5/8 16	1 1/4 32	2 9/16 65	3/8 10	2 51

MODEL	A inch/mm	B inch/mm	C inch/mm	D inch/mm	E** inch/mm	F inch/mm	G inch/mm	H inch/mm	J* inch	K inch/mm	L inch/mm	M inch/mm
V-100	2 51	7/16 11	3 76	3 7/8 98	1/4 6	1 5/16 33	5/8 16	1 11/16 43	1/8-NPT	1 11/16 43	1 25	3/4 19
V-130	2 5/16 59	7/16 11	4 102	4 7/8 124	3/8 10	1 1/2 38	3/4 19	1 15/16 49	1/8-NPT	1 15/16 49	1 1/4 32	1 5/16 24
V-190	3 3/16 81	9/16 14	4 102	5 1/16 129	3/8 10	2 51	7/8 22	2 5/8 67	1/4-NPT	2 3/16 56	1 3/4 44	1 5/16 33
V-250	3 1/2 89	9/16 14	4 102	5 9/16 141	1/2 12	2 1/4 57	1 1/8 29	2 15/16 87	1/4-NPT	2 7/16 62	1 7/8 48	1 1/2 38
V-320	4 7/8 124	3/4 19	4 102	5 9/16 141	1/2 12	2 3/8 60	1 3/8 35	4 1/8 105	3/8-NPT	2 3/4 70	2 3/4 70	1 1/2 38
V-380	4 7/8 124	7/8 22	5 1/2 x 1 1/4 140 x 32	6 7/8 175	3/8 10	2 7/8 73	1 1/2 38	3 7/8 98	3/8-NPT	2 15/16 75	2 1/2 64	2 3/8 60

MODEL	A inch/mm	B inch/mm	C inch/mm	D inch/mm	E inch/mm	F inch/mm	G inch/mm	H** inch/mm	I* inch	J* inch/mm	K inch/mm
BV-60	3 7/8 98	3/4 19	2 1/2 64	3 7/8 98	5/8 16	1 1/4 32	1 1/4 32	1/4 6	1/8-NPT	1/8-NPT	1 11/16 43
BV-130	4 7/8 124	7/8 22	2 3/4 70	4 102	3/4 19	1 5/16 33	1 7/16 37	3/8 10	1/8-NPT	1/4-NPT	1 15/16 49
BV-190	5 1/2 140	1 1/4 32	3 9/16 90	4 102	9/16 14	2 51	1 7/8 48	3/8 10	1/4-NPT	1/4-NPT	2 1/4 57
BV-250	6 3/4 171	1 5/16 33	3 15/16 100	5 127	7/8 22	2 1/8 54	2 3/16 56	1/2 12	1/4-NPT	1/4-NPT	2 7/16 62
BV-320	6 11/16 170	1 5/8 41	4 7/8 124	5 127	1 1/8 29	2 9/16 65	2 3/4 70	1/2 12	3/8-NPT	3/8-NPT	2 3/4 70
BV-380	7 7/8 200	2 51	5 3/4 146	6 152	1 1/8 29	3 76	2 13/16 71	5/8 16	3/8-NPT	3/8-NPT	2 15/16 75

\*NPT Pipe Tap Size \*\*Bolt Size Note: Dimensions & data subject to change without notice.

**See Comparison & Replacement Chart Page 4.**

**PHONE: 800-633-0032 • www.vibco.com • FAX: 401-539-2584**

# Pneumatic Flange Mounted

## ONE PIECE DESIGN

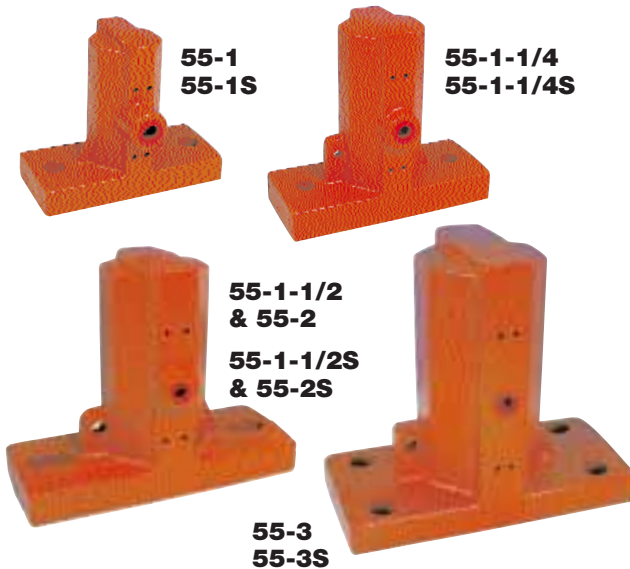

## ALL STEEL MODELS

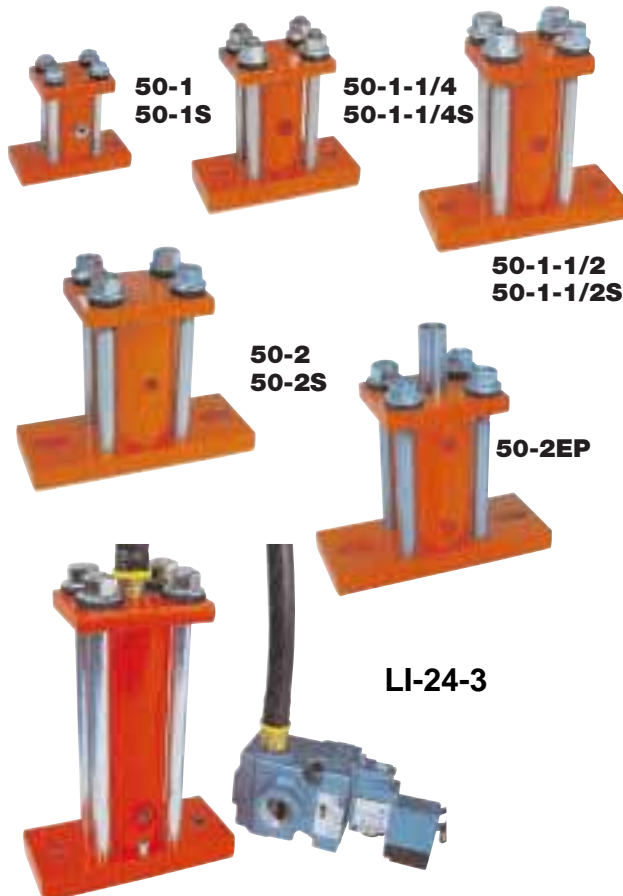

## ONE PIECE DESIGN

- **LOW COST**
- **ONLY 3 PARTS**

VIBCO is the only company featuring both the One Piece Design and the All Steel Models. The one piece housing makes the unit low in cost but still maintaining high quality and long life. The one piece design is the choice for general applications.

## ALL STEEL MODELS

- **BOLT ISOLATION DESIGN FOR LONGER LIFE**
- **IMPACTING IN BOTH UP & DOWN STROKE**

VIBCO's steel units can take more abuse, operate longer with minimal lubrication, and have a longer life expectancy than the one piece design units. The all steel units should be used in continuous duty applications and where long life and high reliability is a must.

### MODEL 50 & 55 STANDARD IMPACT PISTON VIBRATORS:

Most popular piston series because its high impact, linear force and efficient energy transfer assures the flow of materials through bins, chutes, weigh batchers, compacts powdered and viscous materials in containers and forms; activates screens and precipitators. Successfully used in thousands of applications in mining, chemical, plastics, concrete products, foundry, steel and paper industries.

**EXHAUST SILENCER & DUSTPROOFER:** For Silent & Long Stroke Silent Units. A useful accessory that both reduces exhaust noise and protects working parts of vibrator in dusty atmospheres for lower maintenance and prolonged life. Threaded exhaust is ideal for closed sanitary system.

### MODEL 50-S & 55-S SILENT OPERATING PISTON

**VIBRATORS:** In areas where noise is objectionable VIBCO Model S should be used. Quiet because piston impact is eliminated by cushion of air at both ends. High thrust oscillatory action permits operation even at low air pressures. When Silent models are used in place of Impact units use the next larger size.

**MODEL 50-L LONG STROKE PISTON VIBRATORS:** The problem solvers! Extra-long bodies for high amplitude, high force and lower frequency vibration. The larger shake is best for moving fluffy, low density and wet or sticky materials. Especially suited for packaging and screening. Available in 2" and 3" piston sizes. Model 50-LS - Air-Cushioned Model. Silent models also available with silencer & dustproof.

**MODEL 50-2EP EXTENDED PISTON VIBRATORS:** Extended Piston has a 5/8" stroke and threaded extension for attaching rods or bumpers. The air cushioned piston operates quietly at 2400 VPM, 60 PSI & 8 CFM. Ideal for use on portable tote or hoppers.

**MODEL LI HIGH ENERGY IMPACTORS:** All are available in 1-1/4, 2 & 3" piston sizes. The piston impact is adjustable by regulating and controlling the air pressure through a timer and solenoid. Piston impacts can be regulated. The LI-impactors are low in operating cost and used in continuous production applications to move material uninterrupted in bins, hoppers, chutes and feeders. Ask for Li-Bulletin for more technical data. Requires lubricated air.

All pneumatic piston vibrators require lubricated air for proper operation and long life. On 1-1/2" dia. and larger pistons on vertical mount, a spring is required for proper starting.



# Piston Vibrators

## TECHNICAL DATA

## MODEL 50, 55

Piston Size	40 PSI		60 PSI		80 PSI		Contents in Bin
	CFM	VPM	CFM	VPM	CFM	VPM	
1S	3.5	3900	4	5400	5	6500	100-200
1	3.5	6500	4	9000	5	11000	200-400
1-1/4S	5	2400	7	3300	9	4200	200-400
1-1/4	5	4000	7	5500	9	7000	400-1000
1-1/2S	6.5	1700	9	2400	11	3200	400-1000
1-1/2	6.5	2800	9	4000	11	5200	1000-4000
2S	7.5	1950	12	2400	15	3000	1000-4000
2	7.5	3200	12	4000	15	5000	4000-10000
2LS	17	950	26	1200	31	1500	4000-10000
2L	17	1600	26	2000	31	2400	8000-20000
3S	18	1650	25	1950	30	2300	8000-20000
3	18	2700	25	3200	30	3800	10000-30000
3LS	31	800	42	900	51	1000	10000-30000
3L	31	1350	42	1500	51	1700	20000-70000
4S	33	1000	41	1200	50	1400	20000-70000
4	33	1400	41	1600	50	2000	Over - 70000

\* The following data is furnished as a guide in estimating the sizes of piston vibrators for standard hopper shapes containing dry, granular materials of 50 lbs/cu. ft. minimum bulk density. For other sizes and densities, contact VIBCO.

Note: Dimensions and data subject to change without notice.

Data shown is average test data & will vary with cleanliness of the compressed air, lubrication and stiffness of application.

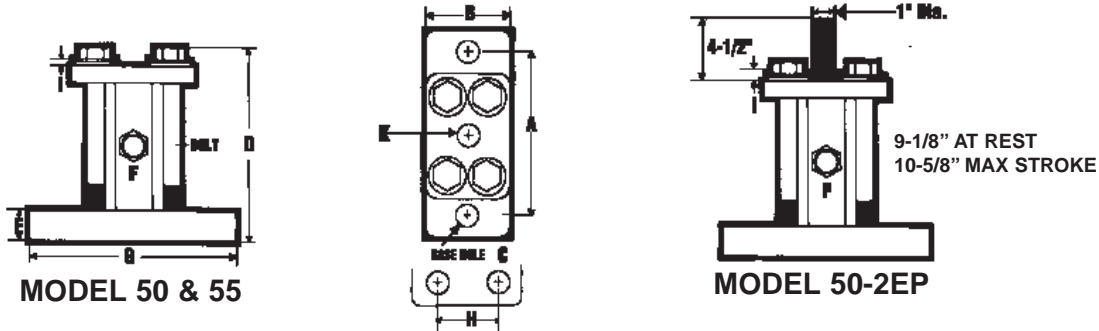

## DIMENSIONS

Model	A		B		C**		D		E		F		G		H		I		K	
	inch	mm	inch	mm	inch	mm	inch	mm	inch	mm	inch	mm	inch	mm	inch	mm	inch	mm	inch	mm
50-1"	3 1/2	89	2	51	1/2	13	4 9/16	116	5/8	16	1/8 - NPT	4 1/2	114	-	-	3/16	5	-	-	-
50-1 1/4"	4 1/2	114	2 1/2	64	1/2	13	6 1/2	165	7/8	22	1/4 - NPT	6	152	-	-	7/32	6	-	-	-
50-1 1/2"	6*	152	3	76	3/4	19	7 15/16	202	7/8	22	1/4 - NPT	7 1/2	191	-	-	9/32	7	-	-	-
50-2"	6*	152	3 1/2	89	3/4	19	7 15/16	202	7/8	22	1/4 - NPT	9	229	-	-	1/4	6	-	-	-
50-2L"	6*	152	3 1/2	89	3/4	19	9 7/16	240	7/8	22	1/4 - NPT	9	229	-	-	1/4	6	-	-	-
50-2EP"	6*	152	3 1/2	89	3/4	19	***	***	7/8	22	3/8 - NPT	9	229	-	-	1/4	6	-	-	-
50-3"	8 7/16	214	4 1/2	114	3/4	19	10 1/2	267	1	25	1/2 - NPT	10 1/2	267	2 1/2	64	5/16	8	-	-	-
50-3L"	8 7/16	214	4 1/2	114	3/4	19	13 1/2	343	1	25	1/2 - NPT	10 1/2	267	2 1/2	64	5/16	8	-	-	-
50-4"	8 7/16	214	5 1/2	140	1	25	11 5/8	295	1	25	1/2 - NPT	10 1/2	267	2 1/2	64	3/4	19	-	-	-
55-1"	3 1/2	89	2	51	1/2	13	3 7/8	98	5/8	16	1/4 - NPT	4 1/2	114	-	-	-	-	-	-	-
55-1 1/4"	4 1/2	114	2 1/2	64	1/2	13	5 5/8	143	7/8	22	1/4 - NPT	6	152	-	-	-	-	-	-	-
55-1 1/2"	7 1/2****	191	3 1/2	89	5/8	16	7 1/4	184	1 1/8	29	1/4 - NPT	9	229	-	-	-	-	-	-	-
55-2"	7 1/2****	191	3 3/16	97	5/8	16	7 1/4	184	1 1/8	29	1/4 - NPT	9	229	-	-	-	-	-	-	-
55-3"	7 3/4	197	5	127	7/8	22	9 7/16	240	1 1/8	29	3/8 - NPT	10 1/2	267	3 1/4	83	-	-	-	-	-
LI-1 1/4"	4 1/2	114	2 1/2	64	1/2	13	8 7/16	217	7/8	22	3/8 - NPT	6	152	-	-	7/32	6	-	-	3/8 - NPT
LI-2"	6*	152	3 1/2	89	3/4	19	8 7/8	225	7/8	22	1/2 - NPT	9	229	-	-	1/4	6	-	-	1/2 - NPT
LI-3"	8 7/16	214	4 1/2	114	3/4	19	13 1/2	343	1	25	1/2 - NPT	10 1/2	267	2 1/2	64	5/16	8	-	-	1/2 - NPT

\*Also available with 7-1/2". \*\*Bolt Size \*\*\*See 50-2EP Diagram Note: Dimensions and data subject to change without notice.

\*\*\*\*Will also fit 6" center hole dimensions (see Dimension A)

# Pneumatic End Mounted

## “BIG RED”



80-1      80-1-1/4      80- 1-1/2      80-2

### END TAPPED



70-1

### END MOUNTED



10-1EM      10-1      30-1      40-1

### WEDGE HEAD

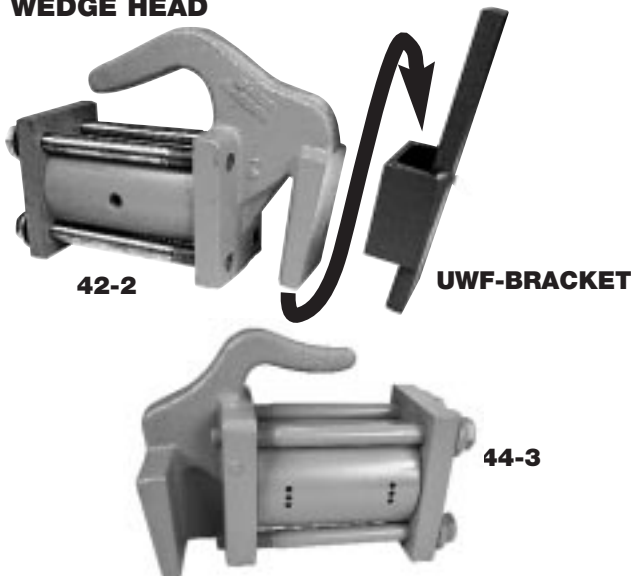

42-2

UWF-BRACKET

44-3

#### MODEL 80 END MOUNTED PISTON VIBRATOR - “BIG RED”:

The new revolutionary lightweight all steel design makes it the most inexpensive unit for the big bin or hopper job, without sacrificing the quality of the more expensive flange mounted units. The single bolt attachment makes them easy and fast to install. The “BIG RED” is supplied either with a silent (air cushioned) piston or the more powerful impacting (piston hitting end cap) standard unit.

O-rings cover the air exhaust holes keeping dust and dirt out of the piston chamber avoiding scoring and damage to piston and cylinder walls and allowing the units to operate in the worst environments. There are four basic models with piston sizes of 1”, 1-1/4”, 1-1/2” and 2”. For smaller sizes see Model 70. The eyebolt on top for a safety chain can be removed for other attachments.

**MODEL 70 END TAPPED VIBRATOR:** End tapped with inch or millimeter thread for attaching to threaded rod or stud. Model 70 can be supplied in many variations; silent (air cushioned) or impacting (piston hitting end cap) with exhaust port for attaching a muffler or air hose to lead off exhausting air. The all steel construction assures long life. Model 70 is an inexpensive solution for moving material in small bins and hoppers as well as screens and small feeders. Force and frequency will vary with air pressure. To order specify inch or millimeter thread; S - for Silent Units and EM - if Exhaust Manifold is required.

**MODEL 10 END MOUNTED PISTON VIBRATOR:** Single attaching head is the basic unit for foundry match plate applications. Available in 5/8, 3/4, 1, 1-1/4, & 1-1/2” piston diameter.

**MODEL 30 END MOUNTED PISTON VIBRATOR:** Double attaching head for core box machines and applications needing more vibration transfer.

**MODEL 40 END MOUNTED PISTON VIBRATOR:** Stud head vibrator ideal for easy movability on small concrete forms or bins.

**MODEL 42 WEDGE HEAD VIBRATOR:** VIBCO Wedge Head Portable Vibrators - High impact vibratory energy facilitates the placement of concrete within intricately shaped forms. Available in 2” piston size. Uses UWF-Female brackets.

**MODEL 44 WEDGE HEAD VIBRATOR:** Railroad carshakers have wedge bracket to fit railroad car’s female “dove-tail” bracket. Available in 3”. See page 41 and 42 for additional Railroad Carshakers.

All pneumatic piston vibrators require lubricated air for proper operation and long life.

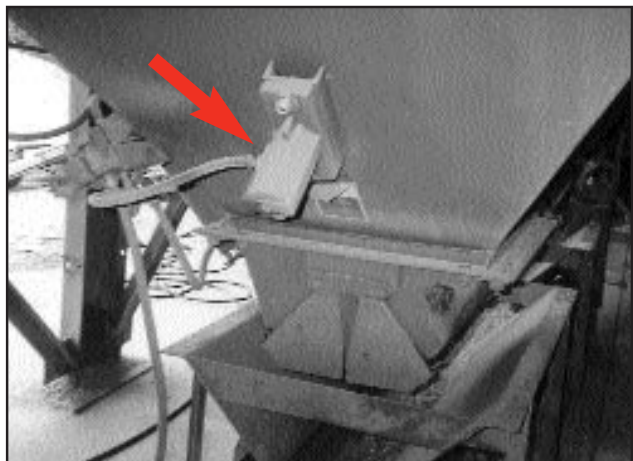

Model 55-1-1/2 on Batch Hopper

# Piston Vibrators

## TECHNICAL DATA

## MODEL 10, 30, 40, 42, 44, 70, 80

Piston Size	40 PSI (3 Bar)		60 PSI (4 Bar)		80 PSI (5 Bar)		*Contents in Bin
	CFM	VPM	CFM	VPM	CFM	VPM	
5/8	2.5	9500	3	12000	4.5	14500	Up to 100 lbs.
3/4	3	7500	3.5	10500	5	13000	100-200
1S	3.5	3900	4	5400	5	6600	100-200
1	3.5	6500	4	9000	5	11000	200-400
1 1/4S	5	2400	7	3300	9	4200	200-400
1 1/4	5	4000	7	5500	9	7000	400-1000
1 1/2S	6.5	1700	9	2400	11	3200	400-1000
1 1/2	6.5	2800	9	4000	11	5200	1000-4000
2S	7.5	1950	12	2400	15	3000	1000-4000
2	7.5	3200	12	4000	15	5000	4000-10000
3S	18	1650	25	1950	30	2300	8000-20000
3	18	2700	25	3200	30	3800	10000-30000

\*The following data is furnished as a guide in estimating the sizes of piston vibrators for standard hopper shapes containing dry, granular materials of 50 lbs/cu. ft. minimum bulk density. For other sizes and densities, contact VIBCO.

Note: Dimensions and data subject to change without notice.

Data shown is average test data & will vary with cleanliness of the compressed air, lubrication and stiffness of application.

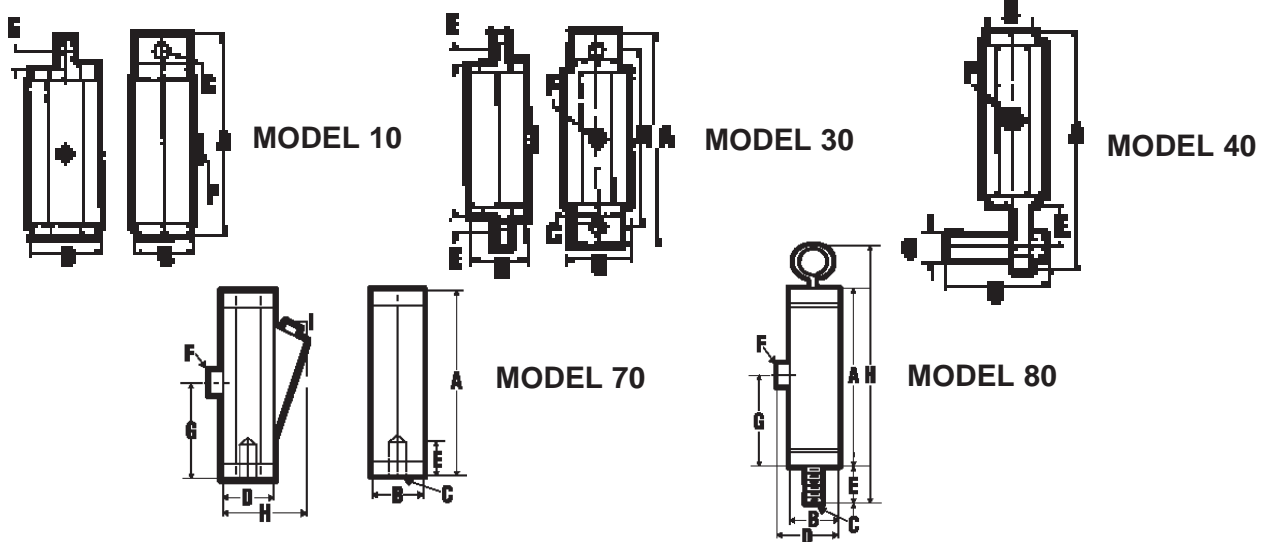

## DIMENSIONS

MODEL	A Inch/mm	B Inch/mm	C Inch/mm	D Inch/mm	E Inch/mm	F Inch/mm	G Inch/mm	H* Inch/mm	I Inch/mm
80 - 1	4 1/2 114	1 1/2 38	1/2-20	2 1/8 54	1 25	1/8 - NPT	2 1/2 64	7 178	-
80 - 1-1/4	5 1/8 130	1 3/4 44	5/8-18	2 1/8 54	1 15/16 33	1/4 - NPT	2 3/16 71	9 15/16 237	-
80 - 1-1/2	6 152	2 51	5/8-18	2 1/2 64	1 3/16 33	1/4 - NPT	4 1/8 105	10 9/16 259	-
80 - 2	8 203	2 1/2 64	7/8-14	3 1/8 78	1 3/8 35	1/4 - NPT	4 1/8 105	11 1/2 292	-
70 - 5/8	4 3/4 120	1 1/4 32	5/16-24 M8x1.25	*1 5/16 33	5/8 16	1/8 - NPT	2 3/8 60	2 3/8 60	1/4 - NPT
70 - 3/4	4 3/4 120	1 3/8 41	3/8-24 M10x1.5	1 3/8 41	5/8 16	1/8 - NPT	2 3/8 60	2 3/8 67	1/4 - NPT
70 - 1	4 3/4 120	1 7/8 48	1/2-20 M12x1.75	1 7/8 48	5/8 16	1/8 - NPT	2 3/8 60	2 3/8 74	1/4 - NPT
70 - 1-1/4	8 203	2 3/16 59	1/2-20 M12x1.75	2 3/16 59	5/8 16	1/4 - NPT	4 101	3 1/2 89	1/4 - NPT
40 - 1	6 3/16 157	1 7/8 48	1/2 13	2 3/4 70	7/16 11	1/8 - NPT	1/2 12	-	-
40 - 1-1/4	9 1/2 241	2 3/16 59	1 25	4 1/4 121	3/4 19	1/4 - NPT	1 25	-	-
30 - 5/8	6 3/16 160	1 1/4 32	5/16 8	1 5/16 33	1/2 12	1/8 - NPT	5 1/16 136	5 1/16 136	-
30 - 3/4	6 3/16 160	1 3/8 41	3/8 10	1 3/16 33	1/2 12	1/8 - NPT	5 1/16 136	5 1/16 136	-
30 - 1	6 3/16 167	1 7/8 48	3/8 10	1 7/8 48	1/2 12	1/8 - NPT	5 1/16 136	6 3/8 162	-
30 - 1-1/4	10 1/2 267	2 3/16 59	1/2 12	2 3/16 59	1 1/16 17	1/4 - NPT	9 1/8 228	9 1/8 232	-
30 - 1-1/2	11 3/8 289	2 3/8 73	5/8 16	2 5/16 73	7/8 22	1/4 - NPT	9 1/2 241	9 1/2 241	-
10 - 5/8	5 1/2 140	1 1/4 38	5/16 8	1 5/16 33	1/2 12	1/8 - NPT	-	-	-
10 - 3/4	5 1/2 140	1 3/8 41	3/8 10	1 3/8 35	1/2 12	1/8 - NPT	-	-	-
10 - 1	5 5/8 143	1 7/8 48	3/8 10	1 7/8 48	1/2 12	1/8 - NPT	-	-	-
10 - 1-1/4	9 1/4 235	2 3/16 59	1/2 12	2 3/16 59	1 1/16 18	1/4 - NPT	-	-	-
10 - 1-1/2	9 11/16 246	2 1/2 64	5/8 16	2 5/16 75	7/8 22	1/4 - NPT	-	-	-

\*For EM Models. Note: Dimensions and data subject to change without notice.

## SILENT MODELS

# High Frequency

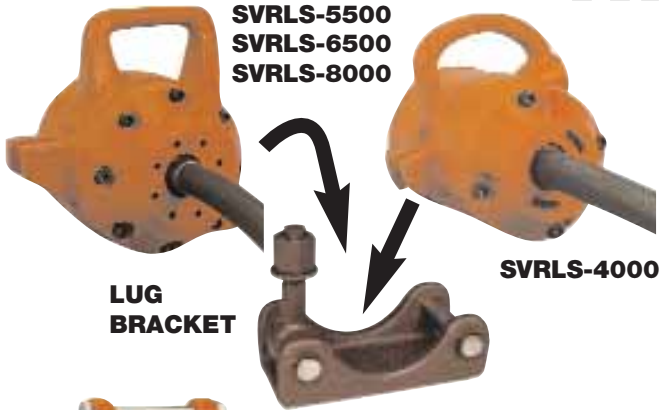

SVRLS-5500  
SVRLS-6500  
SVRLS-8000

LUG  
BRACKET

SVRLS-4000



SVRFS-5500

LC-1 Lug Bracket for all larger lug mount vibrators. LC-2 Lug Bracket for SVRLS-4000 vibrator. These are ideal for fast detachment & portability.

SVRWS-4000W  
with UWF3  
Female  
Bracket

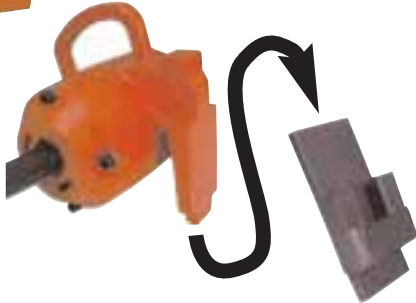

SVRS-5500

SVRFS-4000



## CONVENTIONAL MODELS



SVR-8000



SVRL-5500  
SVRL-6500



SVR-4000



LC-1 LUG BRACKET

## MODEL SVRS "SILENT"

VIBCO's engineers have finally broken the sound barrier of high frequency vibrators and developed a "SILENT" high frequency unit producing the same speed and force as the conventional models. This is a patented design.

### FEATURES:

- **HIGH FREQUENCY, HIGH FORCE**
- **STARTS EVERY TIME**
- **PATENTED SILENT DESIGN**
- **PATENTED "AIR SAVER" CHAMBER**
- **PATENTED WEAR PLATES**

### HOW IT WORKS:

In VIBCO's "SILENT" units, 80-85 dB, the rotor in this bearing-less vibrator spins silently around the shaft instead of spinning and noisily hitting the shaft as in conventional units. In VIBCO's units the exhausting air is also forced through a muffler pad and back over the rotor, further dampening any noise from exhausting air.

The patented air saver design will save air because all the air is not exhausted with every cycle, making them "start every time."

The patented "wear plate" design will prevent end plate wear and cut down on costly maintenance, loss of power, and premature failure.

### MODEL SVRLS-4000, -5500, -6500 & -8000

Model SVRLS-4000, 5500, 6500 and 8000, the industry standard for pipe forms, battery molds, tilt tables, panels, etc. They will fit all lug and cradle brackets on the market.

### MODEL SVRFS-5500, SVRF-5500

Model SVRFS-5500 is used for permanent installations such as vibrating tables, tunnel forms or where it is difficult to reach or get at the units.

### MODEL SVRS-5500

SVRS-5500 fits the SB shoe bracket used for both permanent as well as portable applications.

### MODEL SVRFS-4000

SVRFS-4000 for permanent installations on tables and forms and also to be used with different brackets such as clamp-on, wood forms for portable installations.

### MODEL SVRWS-4000

SVRWS 4000 has a housing with cast-on wedge to fit the UWF female bracket used as a standard bracket on septic tanks, manholes, burial vaults, steps, horizontal panels and other concrete forms. Its lightweight, ease of handling and quick clamp makes it a natural as a portable concrete vibrator.

### MODEL SVRWS-5500

SVRWS-5500 with cast on wedge to fit dovetail brackets on railroad cars. See page 39 and 40. Dovetail brackets can also be mounted to pipe and other concrete forms needing more force than SVRWS-4000.

### CONVENTIONAL MODELS

The conventional SVR units are simple in design and have a dB reading of 95-110. Lower cost units:

SVR-5500 & 6500 same use as SVRLS-5500

SVR-4000 same use as SVRFS-4000

SVR-8000 for big concrete tables.

# Pneumatic Vibrators

## TECHNICAL DATA

Model	Weight		80 PSI			90 PSI			100 PSI			CFM*	dB*
			VPM*	Force		VPM*	Force		VPM*	Force			
	lbs.	kg.		lbs.	N		lbs.	N		lbs.	N		
SVRFS & LS-4000	22	10	11500	3600	16000	12500	4000	17800	13500	4400	19500	40	78
SVR-4000	23	10.4											90
SVRS, FS-5500	40	18	9000	4950	22000	10000	5500	24500	10500	6100	27100	56	82
SVRLS-5500	43	19.5											
SRL-5500	33	15											
SVRLS-6500	45	20.4	8800	5575	24800	9500	6500	28900	10000	7200	3200	58	80
SRL-6500	39	17.8											98
SVRLS-8000	47	21.3	8500	7625	33900	8700	8000	35600	9500	9550	42500	62	82
SVR-8000	51	23.1											98
SVRWS-4000	23	10.4	11500	3600	16000	12500	4000	17800	13500	4400	19500	40	78
SVRWS-5500	60	27.5	9000	4950	22000	10000	5500	24500	10500	6100	27100	56	82
SVRWS-6500	61	28	8800	5545	24800	9500	6500	28900	10000	7200	32000	58	85

\* Frequency and Air Consumption will vary with load \*\* dB at 3' (1 meter) on A-scale N = Centrifugal force in Newton

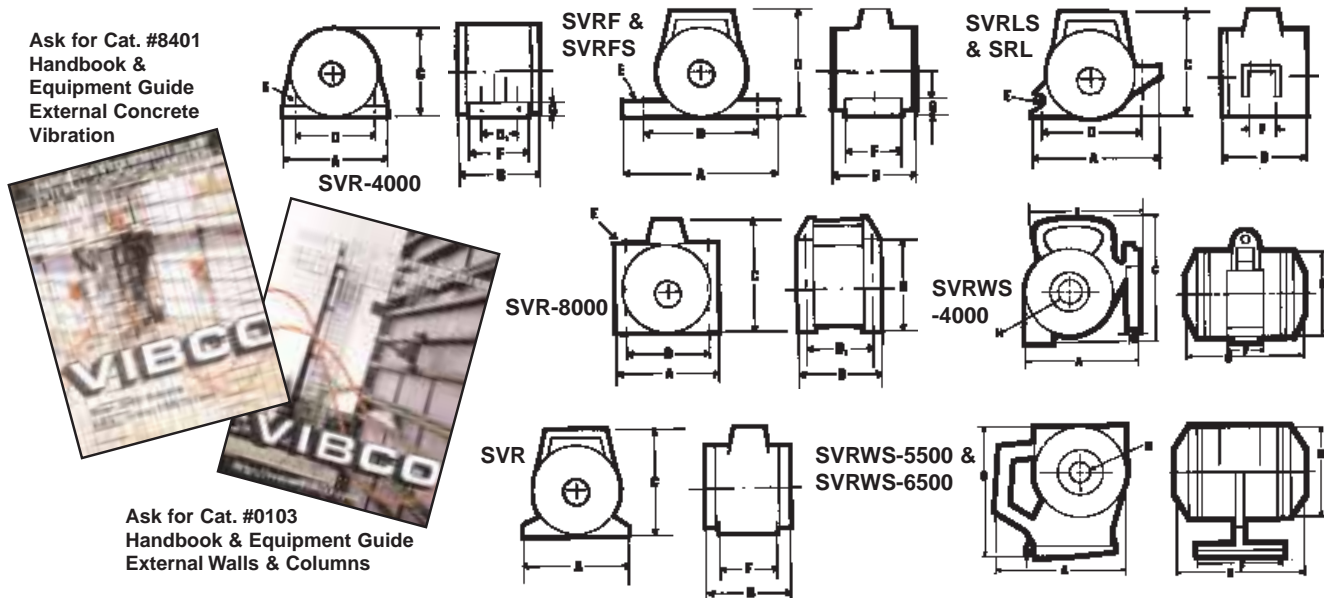

## DIMENSIONS

Model	A Inch/mm		B Inch/mm		C Inch/mm		D x D <sub>1</sub> Inch/mm		E Inch/mm	F Inch/mm		G Inch/mm		H* Inch/mm		
SVR-4000	7 1/2	191	6 1/8	156	5	127	6 1/4	2 51	1/2	12	3 7/16	87	7/8	22	3/4	19
SVR-5500	7	178	6 1/16	154	7 3/8	187	—	—	—	3 1/2	89	—	—	—	3/4	19
SVRL-5500, 6500	9 1/2	241	6 1/8	156	9 1/4	235	8	203	1	25	1 1/4	32	—	—	3/4	19
SVRF-5500	10 1/4	260	6 1/8	156	8 1/8	206	8	203	3/4	19	3 1/4	83	—	—	3/4	19
SVR-8000	9 3/8	238	6 3/8	162	9	229	7 x 3 1/8	178 x 79	3/4	19	—	—	6 1/2	162	3/4	19
SVRFS-4000	7 5/8	194	8 1/16	205	7 3/8	185	6	152	5/8	16	2	51	3/4	19	3/4	19
SVRLS-4000	7	178	8	203	7 1/2	190	6	152	3/8	10	7/8	22	—	—	3/4	19
SVRLS-5500, 6500, 8000	9 1/2	241	8 1/16	205	9 1/4	235	7 3/4	197	1	25	1 1/4	32	—	—	3/4	19
SVRFS-5500	10 1/2	257	8 5/8	219	8 1/8	206	8	203	1 1/16	18	3 1/4	83	1 1/8	29	3/4	19
SVRS-5500	7	178	8 1/2	216	7 3/8	187	—	—	—	—	3 1/2	89	—	—	3/4	19
SVRWS-4000	6 7/8	175	8 1/16	205	7 1/8	181	5 1/8	130	7	178	2 3/16	56	1 1/16	18	3/4	19
SVRWS-5500, 6500	8 5/8	219	8 5/8	219	9 7/8	251	6 1/8	156	—	—	5 1/2	140	1 1/8	29	3/4	19

\*Hose Diameter Note: Dimensions and data subject to change without notice.

## PNEUMATIC & HYDRAULIC VIBRATORS



**LH-1000**  
**LH-2000**



**LHS-1800**  
**HS-2500**



**LH-3500**  
**LH-5000**



**B-190**



**B-250**



**B-320**



**HLF-1300**



**HLF-700**

**PC-3500**  
**HC-3500**



**PF-3500**  
**(HF-3500)**



**HL-3000**

# Pneumatic &

## MODEL PF, HF, PC & HC "BIG-BUSTER"

### PATENTED DESIGNS

VIBCO has developed a new revolutionary vibration isolation device eliminating vibration transfer from the vibrator part of the Big Buster to the drive motor.

A vibration isolating coupling is mounted between the eccentric shaft and the motor drive shaft eliminating any vibration transfer through the shaft. Another vibration isolating coupling is connected between the vibrator housing and the motor housing eliminating all vibration transfer.

### GENERAL FEATURES

Big Buster vibrators provide high force at low frequency. They are designed for continuous duty. All models are available in pneumatic or hydraulic drive. Big Buster units are designed with sealed bearings. Airline lubrication is required for the air motor vanes.

### ADVANTAGES

With this unique design, premature failure of the drive unit is eliminated, and the full life can be expected of the drive unit, which will drastically add to the unit life and eliminate costly shutdowns and maintenance costs. The unit can now truly be used continuously and economically which is the BIG advantage over competitive units.

### WHERE TO USE?

These units are ideal for the toughest applications from unloading railroad cars to moving materials in huge bins and hoppers (capacity over 150,000 lbs.) Precise speed control allows "tuning" of the vibrator for best results in any application. Big Busters are available in clamp on base for portability and bolt-on base for permanent mounting.

# Hydraulic

### PATENTED DESIGNS

### GENERAL FEATURES

VIBCO's hydraulic vibrators operate in any position and are not affected by dirty, muddy or wet locations. They can operate on pressures up to 3000 PSI making them ideal to use with construction and form equipment for a variety of applications.

### MODEL LH

VIBCO's new patented LH-series of heavy duty hydraulic vibrators have been designed to eliminate the constant failures and short life associated with hydraulic vibrators using a hydraulic motor with needle bearings. Use of large roller & ball bearings provide these vibrators with a longer, trouble-free, service life. The LH-series offers a compact design and can handle pressures up to 3000 PSI. The LH vibrators produce a linear force that makes the unit ideal for feeders, packing tables as well as moving material in bins & hoppers, as a dump truck body vibrator, or consolidating concrete or asphalt. LHS units with space saver design and sinusoidal rotary force, ideal for bins & hoppers.

### MODEL HLF

The small version of the Big Buster HF-Units are equipped with an internal coupling to minimize the wear of the hydraulic motor. These small and powerful high speed 9000 RPM vibrators offer an inexpensive solution to many material handling problems. HL 3000 same design as the HF-Fit LC-1 Lug Bracket. Creates 3000 lbs. force at 7000 RPM - ideal for concrete applications.

### MODEL B

Hydraulic fluid under pressure drives a specially designed and patented turbine wheel producing high frequency vibration with noise levels as low as 60-62 dB at maximum speed. A real low cost unit ideal for O.E.M equipment.

# Hydraulic Vibrators

- AIR & HYDRAULIC DRIVE**
- ADJUSTABLE SPEED**
- QUIET**
- FORCES TO 3500 LBS.**
- FOOT & CLAMP MOUNT**
- CONTINUOUS DUTY**
- SPEEDS TO 5600 VPM**

## TECHNICAL DATA

Pneumatic Models	Weight		60 PSI				Hydraulic Models	Weight		Avg. PSI	Speed VPM	GPM (max.)	Force		
			Speed VPM	SCFM	lbs	N							lbs.	N	dB*
PF-800	60	27	4000	11	800	3559	HF-800	60	27	600	5000	3.2	1300	5784	72
PF-1200	60	27	3500	21	1200	5338	HF-1200	60	27	800	4500	2.9	1900	8452	74
PF-1500	60	27	3500	31	1500	6672	HF-1500	60	27	900	4000	2.6	2000	8898	76
PF-PC-3500	72	33	3500	39	3500	15572	HF-HC-3500	72	33	1200	3500	2.4	3500	15572	80
							HL-3000	39	17.7	1000	5000	3.2	3400	15124	76
							HLF-700	14	6.5	900	9000	2.8	700	3114	72
							HLF-1300	20	9	1000	9000	2.8	1300	5784	72

\*Decibels at 3' (1 meter) on A-scale  
N = Centrifugal force in Newton  
Frequency will vary with load.

\*\*\*Maximum pressure 3000 PSI.

Model	Weight		600 PSI				800 PSI				1000 PSI			
			VPM	GPM	lbs	N	VPM	GPM	lbs	N	VPM	GPM	lbs	N
B-190	1	.453	4600	4.5	189	891	6100	4.8	332	77	7400	6.5	488	221
B-250	2	.907	4200	4.5	280	1246	5000	4.5	397	1766	5800	6.5	534	242
B-320	3 1/2	1.6	3700	5.0	301	1339	4500	6.0	445	1980	5300	7.0	617	280

N = Centrifugal force in Newton. Maximum pressure 3000 PSI. Frequency will vary with load.

### B-MODELS

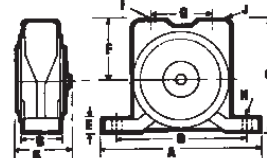

Model	2.5 Gal.			3 Gal.			4 Gal.			Weight		dB
	VPM	PSI	Force lbs.	VPM	PSI	Force lbs.	VPM	PSI	Force lbs.			
LH-1000*	2500	350	270	3600	400	600	4700	600	1000	30	13.6	72
LH-3500*	4000	500	2100	4600	600	2800	5300	850	3500	62	28	76
LHS-1500*	3200	500	700	4500	600	1500	5300	750	1800	40	18	74

Average figures, subject to change without notice. \* LH-1000, LH-3500, LHS-1500 Standard Sizes LH-2000, 2000 lbs. at 4600 VPM, LH-5000, 5000 lbs. at 5300 VPM, LHS-2500, 2500 lbs. at 5000 VPM. Frequency will vary with load.

## DIMENSIONS:

Model	A		B		C		D		E		F*		G		H		I		J		K	
	Inch	mm	Inch	mm	Inch	mm	Inch	mm	Inch	mm	Inch	mm	Inch	mm	Inch	mm	Inch	mm	Inch	mm	Inch	mm
B-190	5 1/4	133	1 1/16	27	4 5/8	117	4	102	1 3/16	21	3/8	10	1 5/16	33	2 1/8	54	3/8 - NPT	3/8 - NPT	3 1/4	83		
B-250	7	178	1 1/4	32	5 3/8	137	5	127	1	25	1/2	13	2 1/4	57	3 1/2	89	1/2 - NPT	1/2 - NPT	3 3/8	86		
B-320	6 7/8	117	1 11/16	43	5 7/8	149	5	127	1 1/16	27	1/2	13	2 5/8	67	3 3/4	95	1/2 - NPT	1/2 - NPT	3 5/8	92		
PF-HF-800, 1200, 1500	10 3/8	265	8 3/4	222	11 1/4	286	8 1/2	216	3/4 - 16SAE	3/4	19	-	-	3	76	-	-	-	-	-	-	-
PF-HF-3500	10 3/4	273	9 1/4	235	12 5/8	321	8 1/2	216	3/4 - 16SAE	5/8	16	2 1/2	64	4 1/4	108	-	-	-	-	-	-	-
PC-HC-3500	12 1/2	318	10 3/4	273	12 1/4	311	10 1/16	256	3/4 - 16SAE	1 1/4	12NF	-	-	1 3/16	30	-	-	-	-	-	-	-
HLF-700	5	127	4 1/2	114	7	178	3 1/2	89	9/16 - 18SAE	1/2	13	-	-	-	-	-	-	-	-	-	-	
HLF-1300	5 3/4	146	5 1/8	130	7 5/8	194	4 1/2	114	9/16 - 18SAE	1/2	13	-	-	-	-	-	-	-	-	-	-	
HL-3000	8 3/4	222	8 3/4	222	11 1/4	286	7 3/4	197	3/4 - 16SAE	1	25	-	-	1 1/16	27	-	-	-	-	-	-	-

Model	G		D		F		A		C		B		E	
	Inch	mm	Inch	mm	Inch	mm	Inch	mm	Inch	mm	Inch	mm	Inch	mm
LH-1000	3	76	4 1/2	114	1/2	12	5 1/2	140	8 1/2	216	4 3/4	121	3/8 - NPT	
LH-2000	3	76	4 1/2	114	1/2	12	5 1/2	140	10 1/2	267	4 3/4	121	3/8 - NPT	
LH-3500	3	76	8 1/2	216	3/4	19	10 1/4	260	11 3/8	289	6 1/8	156	3/8 - NPT	
LH-5000	3	76	8 1/2	216	3/4	19	10 1/4	260	13 3/8	340	6 1/8	156	3/8 - NPT	
LHS-1500			8 1/2	216	3/4	19	10 1/4	260	9 1/4	235	6 1/8	156	3/8 - NPT	
LHS-2500			8 1/2	216	3/4	19	10 1/4	260	10 1/4	260	6 1/8	156	3/8 - NPT	

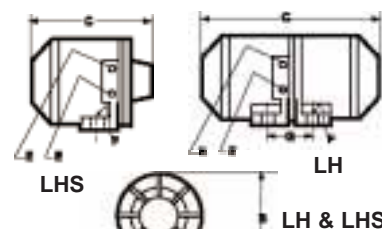

\*Bolt Size \*\* dB at 3' (1 meter) on A-scale N = Centrifugal force in Newton  
Note: Dimensions and data subject to change without notice.

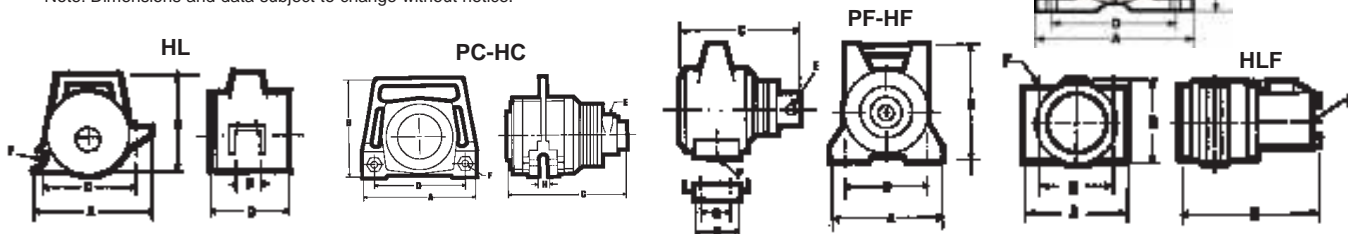

# Model SCR - Adjustable

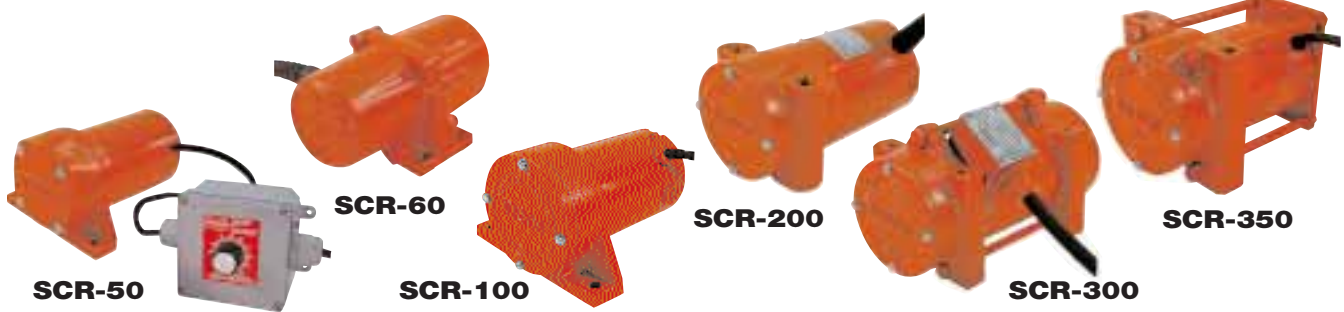

## MODEL SCR Adjustable Speed & Force

### FEATURES:

- 0-4000 RPM • ADJUSTABLE FORCE
- TOTALLY ENCLOSED, SILENT
- HEAVY, CONTINUOUS DUTY
- 115-VOLT PLUG-IN
- EASY SPEED DIAL CONTROL

Another first by VIBCO – A **noiseless**, heavy duty electric vibrator that can be force and speed **adjusted** while running. Unlike old-fashioned, noisy electro-magnetic vibrators, this newly developed silent motor vibrator can meet even the most stringent anti-noise pollution requirement.

Model SCR consists of a rugged, permanent magnet DC motor, and SCR control, which is composed of a solid state, full wave rectifier and

standard 115-volt AC current. No special wiring or circuitry is needed. Accurate and reliable performances throughout the full speed range. Totally enclosed, non-vented housing makes the SCR ideal for use inside or outside in dusty or wet locations. Easy to adjust eccentric settings give additional adjustability. SCR is continuous duty rated even at maximum eccentric setting.

### WHERE TO USE:

**BINS, CHUTES:** Controlled feed. Dial control vibration gives positive flow rate from trickle to torrent, even with hard to move materials or different bin contents.

**PACKAGING:** Select and settle. Select ideal shake for optimum densification and settling.

**SCREENING:** Fast, non-blinding. For sifting, scalping and sorting, controlled vibration gives fastest and most complete results.

**TEST TABLES:** Verify part integrity, simulate handling and over the road transport. Low cost, full range control gives multitude of speeds, "G" values and amplitudes necessary to meet most specs.

### TECHNICAL DATA

Model	Force (Impact) lbs./N Adjustable		Amp.	***Volt	Ph.	Vibrations per Minute		Wt.		dB*
	lbs.	N				Cont. Duty	Int. Duty	lbs.	kg.	
SCR-50	50	223	2.5	115/230	1	950-2500	2500-4000	8	3.6	71
SCR-60‡	60	267	2.5	115/230	1	950-2500	2500-4000	5 and 8**	2.3/3.6	68
SCR-100	100	445	1.3	115/230	1	950-2500	2500-4000	11	5.0	68
SCR-200	200	890	2.6	115/230	1	950-2500	2500-4000	12	5.4	70
SCR-300	300	1335	1.7	115/230	1	950-2500	2500-4000	16	7.3	70
SCR-350	350	1558	3.0	115/230	1	950-2500	2500-4000	20	9.1	71
SCRW-400‡	400	1780	1.7	115/230	1	950-2500	2500-4000	12	5.5	70
SCR-400	400	1780	2.0	115/230	1	950-2500	2500-4000	16	7.3	70
SCR-500	500	2225	3.5	115/230	1	950-2500	2500-4000	43	19.5	70
SCR-1000	1000	4449	6.5	115/230	1	950-2500	2500-4000	58	26.0	72

\*Decibel at 3' (1 meter on A-Scale) N = Centrifugal force in Newton \*\*\*50 or 60Hz ‡Watertight  
Note: Dimensions and data subject to change without notice.

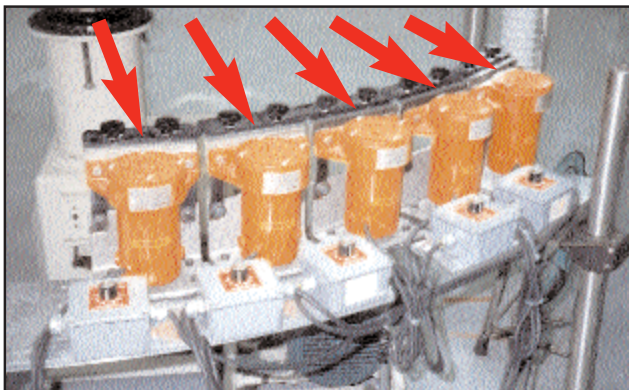

SCR-100 on Filling Station

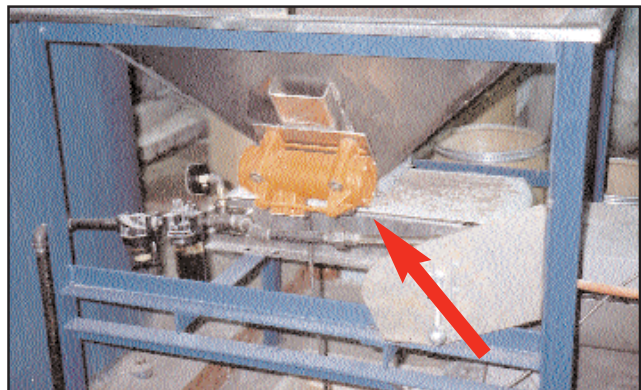

SCR-200 keeps material flowing evenly to belt conveyor



# Speed & Force Electric Vibrators



## DIMENSIONS

Model	L		W		H		A		B		C*		D		E	
	inch	mm	inch	mm	inch	mm	inch	mm	inch	mm	inch	mm	inch	mm	inch	mm
SCR-50	5 <sup>7</sup> / <sub>8</sub>	149	5	127	3 <sup>5</sup> / <sub>8</sub>	64	4	102	—	—	3 <sup>3</sup> / <sub>8</sub>	10	3	76	3 <sup>5</sup> / <sub>16</sub>	100
SCR-60	6 <sup>3</sup> / <sub>8</sub>	162	4 <sup>1</sup> / <sub>2</sub>	114	3 <sup>1</sup> / <sub>4</sub>	83	3 <sup>5</sup> / <sub>8</sub>	64	1 <sup>5</sup> / <sub>16</sub>	33	5 <sup>5</sup> / <sub>16</sub>	8	3	76	—	—
SCR-100	6 <sup>3</sup> / <sub>4</sub>	187	6	152	4 <sup>1</sup> / <sub>4</sub>	108	5	127	—	—	3 <sup>3</sup> / <sub>8</sub>	10	4	102	—	165
SCR-200	8 <sup>3</sup> / <sub>16</sub>	208	4 <sup>7</sup> / <sub>8</sub>	124	4 <sup>1</sup> / <sub>8</sub>	105	3 <sup>1</sup> / <sub>2</sub>	89	—	—	1 <sup>1</sup> / <sub>2</sub>	12	4	102	6 <sup>1</sup> / <sub>2</sub>	165
SCR-300	8 <sup>1</sup> / <sub>2</sub>	216	4 <sup>1</sup> / <sub>8</sub>	105	5	127	3	76	5 <sup>3</sup> / <sub>4</sub>	145	5 <sup>5</sup> / <sub>16</sub>	8	3 <sup>3</sup> / <sub>16</sub>	90	6 <sup>1</sup> / <sub>2</sub>	—
SCR-350	8 <sup>1</sup> / <sub>4</sub>	210	5 <sup>5</sup> / <sub>8</sub>	143	5 <sup>1</sup> / <sub>4</sub>	133	4 <sup>1</sup> / <sub>2</sub>	114	—	—	1 <sup>1</sup> / <sub>2</sub>	12	5 <sup>1</sup> / <sub>16</sub>	128	—	165
SCRW-400	9	229	6 <sup>1</sup> / <sub>4</sub>	159	5 <sup>5</sup> / <sub>8</sub>	137	5 <sup>1</sup> / <sub>4</sub>	133	4 <sup>1</sup> / <sub>4</sub>	114	7 <sup>1</sup> / <sub>16</sub>	14	—	—	—	—
SCR-400	9	229	4 <sup>1</sup> / <sub>8</sub>	105	5	127	3	76	5 <sup>3</sup> / <sub>4</sub>	145	5 <sup>5</sup> / <sub>16</sub>	8	3 <sup>3</sup> / <sub>16</sub>	90	6 <sup>1</sup> / <sub>2</sub>	—
SCR-500	13 <sup>3</sup> / <sub>16</sub>	335	5 <sup>3</sup> / <sub>4</sub>	146	6 <sup>1</sup> / <sub>2</sub>	165	4 <sup>1</sup> / <sub>2</sub>	114	8 <sup>15</sup> / <sub>16</sub>	227	1 <sup>1</sup> / <sub>2</sub>	12	5 <sup>1</sup> / <sub>16</sub>	128	—	—
SCR-1000	14 <sup>1</sup> / <sub>4</sub>	362	6 <sup>1</sup> / <sub>2</sub>	165	7 <sup>1</sup> / <sub>2</sub>	190	5	127	9 <sup>3</sup> / <sub>8</sub>	238	5 <sup>5</sup> / <sub>8</sub>	16	6	140	—	—

\*Bolt size to be used Note: Dimensions and data subject to change without notice.

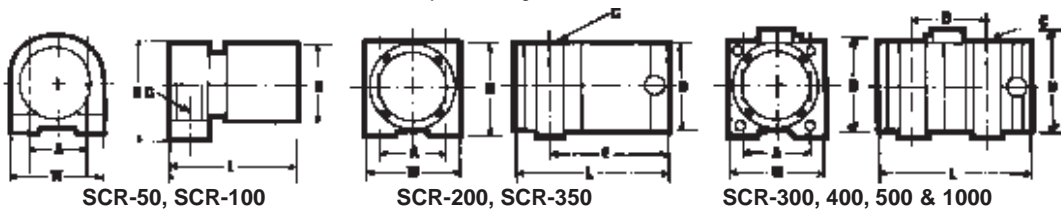

SCR-300 on Box Dumper to prevent hang-ups.

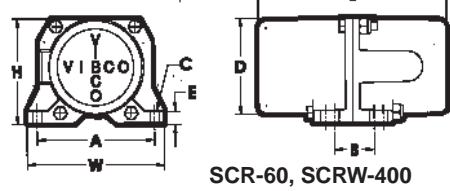

Ask for Cat. #0104  
Electric Vibrators  
Adjustable Speed & Force

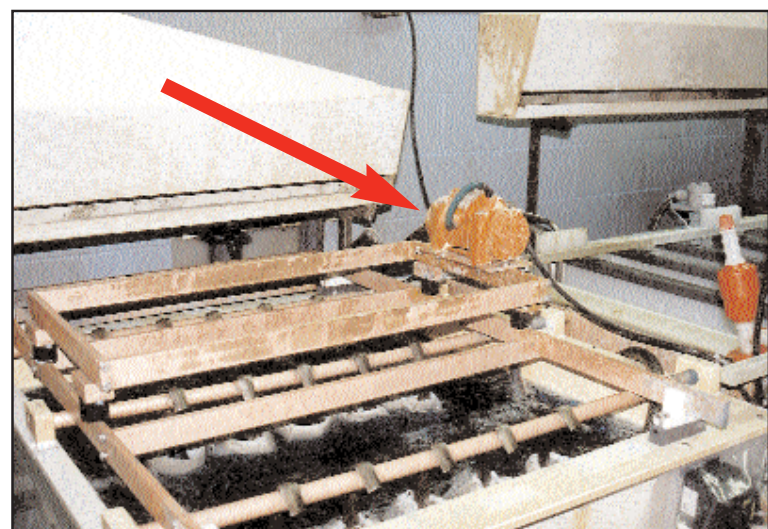

SCR-300 on PC-Board Frame

# Model 2P, 4P, 6P, 8P

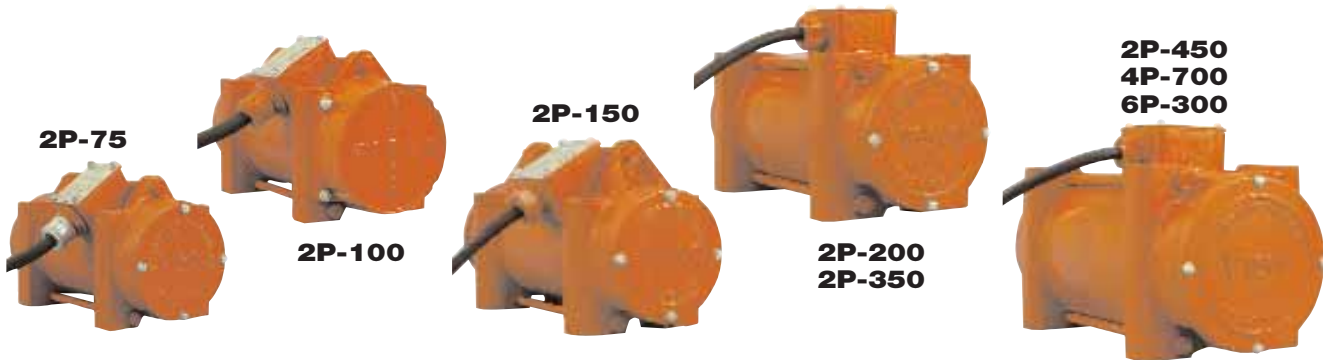

- **TOTALLY ENCLOSED**
- **FOR INDOOR OR OUTDOOR USE**
- **COMPLETELY NOISELESS**
- **ADJUSTABLE ECCENTRICS**
- **SINGLE & 3 PHASE**

VIBCO noiseless motor vibrators made in the U.S. by skilled American craftsmen follow American NEMA and ASTM standards. VIBCO Vibrators are totally enclosed, continuous duty and completely noiseless. They can be used inside or outside, in dust, dirt, rain or snow. VIBCO's lines of heavy duty vibrators will solve any vibration problem such as: speed the flow of bulk materials through the smallest bin, hopper, and chute, to the largest silo; pack materials in drums and bags; consolidate concrete in pipe, precast and prestressed industries; for screens and screeds and a variety of other industrial applications.

## WHY VIBCO?? BECAUSE . . . . .

**CHOICE:** 31 models all made in the U.S.A. Heavy duty and completely self-contained units.

**DURABILITY:** Built stronger throughout; years of service in all types of applications, inside and outside, have proven the VIBCO quality.

**EFFECTIVE:** Multi-directional force proven safest to your equipment and most efficient.

**NOISELESS:** No more sound than an electric motor.

**ECONOMY:** Maintenance free, no costly controls, low operating cost.

**GUARANTEE:** Every VIBCO Vibrator is fully guaranteed both mechanically and performance-wise.

**SERVICE:** Over forty years of vibration know-how, and distributors throughout the U.S.A.

- DESIGN:**
- Adjustable eccentrics for easy change of force to suit application.
  - Load equally distributed over bearings for additional life.
  - Unloaded rotor on the larger units to prevent burnout from rotor hitting stator lamination.
  - Oversized electric motor for higher safety factor - watt/lbs. impact.
  - High heat resistant winding to take additional overload and heat.
  - Oversized bearings for longer life.
  - Mounting bolts over force center for efficient vibration transfer.
  - Terminal box for easy connection and change of voltage.
  - Internal vent holes for better air circulation cooling in high temperature application.

2P Models with 3600 rpm are the most versatile and popular vibrators. Centrifugal force output from 50-5600 lbs. used on all types of bins containing fine to granular materials, for packing coarse materials and casting concrete, etc.

4P Models with 1800 rpm have a force output of 100 to 15,000 lbs. Used on bins containing lumpy or sticky materials for packing light fluffy materials, also a typical screen vibrator.

6P and 8P Models with 1200 and 900 rpm are used in applications requiring low frequency and very high amplitude vibration such as screening and packing of very light and fluffy materials.

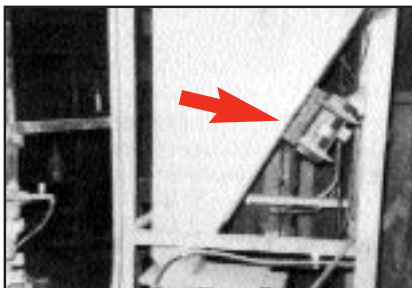

Vertically mounted 2P-450 on Crushed Cullet Hopper.

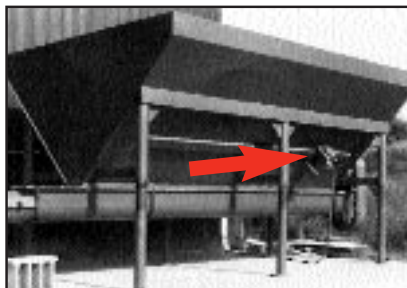

4P-700 on Woodchip Bin with Screw Feeder.

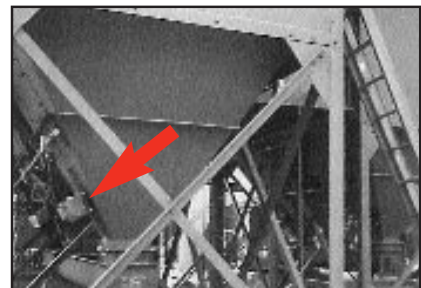

2P-200 on Dust Collector Hoppers.

# Heavy Duty Electric

4P-1000,  
6P-500



4P-2000, 4P-5000  
6P-1000, 8P-500

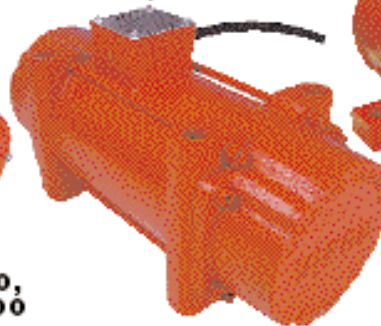

2P-800, 2P-1700,  
2P-2500, 2P-3500

4P-10000

## DIMENSIONS

Model	Phase	A Inch/mm		B Inch/mm		C* Inch/mm		L Inch/mm		W Inch/mm		H Inch/mm		D Inch/mm		E Inch/mm	
2P-75	1 & 3	3	76	4 <sup>11</sup> / <sub>16</sub>	119	5 <sup>5</sup> / <sub>16</sub>	8	7 <sup>7</sup> / <sub>8</sub>	200	4 <sup>1</sup> / <sub>8</sub>	105	5	127	3 <sup>9</sup> / <sub>16</sub>	90	4 <sup>1</sup> / <sub>8</sub>	105
2P-100	1 & 3	3	76	4 <sup>13</sup> / <sub>16</sub>	122	5 <sup>5</sup> / <sub>16</sub>	8	8 <sup>3</sup> / <sub>16</sub>	208	4 <sup>1</sup> / <sub>8</sub>	105	5	127	3 <sup>9</sup> / <sub>16</sub>	90	4 <sup>1</sup> / <sub>8</sub>	105
2P-150	1 & 3	3 <sup>1</sup> / <sub>2</sub>	89	6 <sup>3</sup> / <sub>8</sub>	162	1 <sup>1</sup> / <sub>2</sub>	13	10 <sup>3</sup> / <sub>4</sub>	273	4 <sup>7</sup> / <sub>8</sub>	124	6 <sup>1</sup> / <sub>4</sub>	159	4	102	4 <sup>1</sup> / <sub>4</sub>	108
2P-200	1 & 3	4 <sup>1</sup> / <sub>2</sub>	114	7	178	1 <sup>1</sup> / <sub>2</sub>	13	11 <sup>1</sup> / <sub>2</sub>	292	5 <sup>3</sup> / <sub>4</sub>	146	6 <sup>3</sup> / <sub>4</sub>	171	5	127	5	127
4P-350																	
4P-600	1 & 3	4 <sup>1</sup> / <sub>2</sub>	114	7 <sup>7</sup> / <sub>8</sub>	200	1 <sup>1</sup> / <sub>2</sub>	13	13	330	5 <sup>3</sup> / <sub>4</sub>	146	6 <sup>3</sup> / <sub>4</sub>	171	5	127	5	127
2P-450	1	5	127	8 <sup>3</sup> / <sub>8</sub>	213	5 <sup>5</sup> / <sub>8</sub>	16	13 <sup>1</sup> / <sub>2</sub>	343	6 <sup>1</sup> / <sub>2</sub>	165	7 <sup>1</sup> / <sub>2</sub>	191	6	152	6	152
	3	5	127	(7 <sup>5</sup> / <sub>8</sub> )	194	5 <sup>5</sup> / <sub>8</sub>	16	12 <sup>3</sup> / <sub>8</sub>	314	6 <sup>1</sup> / <sub>2</sub>	165	7 <sup>1</sup> / <sub>2</sub>	191	6	152	6	152
2PS-450	1	5	127	(7 <sup>5</sup> / <sub>8</sub> )	194	5 <sup>5</sup> / <sub>8</sub>	16	12 <sup>3</sup> / <sub>8</sub>	314	6 <sup>1</sup> / <sub>2</sub>	165	7 <sup>1</sup> / <sub>2</sub>	191	6	152	6	152
	3	5	127	(6 <sup>7</sup> / <sub>8</sub> )	175	5 <sup>5</sup> / <sub>8</sub>	16	11 <sup>1</sup> / <sub>4</sub>	286	6 <sup>1</sup> / <sub>2</sub>	165	7 <sup>1</sup> / <sub>2</sub>	191	6	152	6	152
4P-700	1 & 3	5	127	(8 <sup>3</sup> / <sub>8</sub> )	213	5 <sup>5</sup> / <sub>8</sub>	16	13 <sup>1</sup> / <sub>8</sub>	333	6 <sup>1</sup> / <sub>2</sub>	165	7 <sup>1</sup> / <sub>2</sub>	191	6	152	6	152
4P-1000 6P-500	1 & 3	5	127	8 <sup>3</sup> / <sub>8</sub>	213	5 <sup>5</sup> / <sub>8</sub>	16	15 <sup>1</sup> / <sub>2</sub>	394	6 <sup>1</sup> / <sub>2</sub>	165	7 <sup>5</sup> / <sub>8</sub>	194	6	152	6	152
2P-800	1	5 <sup>1</sup> / <sub>2</sub>	140	9 <sup>5</sup> / <sub>8</sub>	244	5 <sup>5</sup> / <sub>8</sub>	16	15 <sup>1</sup> / <sub>4</sub>	387	7 <sup>1</sup> / <sub>2</sub>	191	8 <sup>1</sup> / <sub>2</sub>	216	7	178	7	178
	3	5 <sup>1</sup> / <sub>2</sub>	140	8 <sup>5</sup> / <sub>8</sub>	219	5 <sup>5</sup> / <sub>8</sub>	16	14 <sup>3</sup> / <sub>8</sub>	365	7 <sup>1</sup> / <sub>2</sub>	191	8 <sup>1</sup> / <sub>2</sub>	216	7	178	7	178
2P-1700	3	5 <sup>1</sup> / <sub>2</sub>	140	10 <sup>13</sup> / <sub>16</sub>	259	5 <sup>5</sup> / <sub>8</sub>	16	16 <sup>1</sup> / <sub>2</sub>	419	7 <sup>1</sup> / <sub>2</sub>	191	8 <sup>1</sup> / <sub>2</sub>	216	7	178	7	178
4P-1400	1 & 3																
2P-2500	3	5 <sup>1</sup> / <sub>2</sub>	140	11 <sup>5</sup> / <sub>8</sub>	295	5 <sup>5</sup> / <sub>8</sub>	16	17 <sup>1</sup> / <sub>2</sub>	445	7 <sup>1</sup> / <sub>2</sub>	191	8 <sup>1</sup> / <sub>2</sub>	216	7	178	7	178
2P-3500																	
2P-4500	3	5 <sup>1</sup> / <sub>2</sub>	140	11 <sup>5</sup> / <sub>8</sub>	295	5 <sup>5</sup> / <sub>8</sub>	16	18 <sup>1</sup> / <sub>2</sub>	470	7 <sup>1</sup> / <sub>2</sub>	191	8 <sup>1</sup> / <sub>2</sub>	216	7	178	7	178
2P-5500	3	7 <sup>7</sup> / <sub>8</sub>	200	12 <sup>13</sup> / <sub>16</sub>	325	1	25	22 <sup>1</sup> / <sub>4</sub>	565	10 <sup>1</sup> / <sub>4</sub>	260	10 <sup>1</sup> / <sub>2</sub>	267	8 <sup>7</sup> / <sub>8</sub>	225	8 <sup>7</sup> / <sub>8</sub>	225
4P-2000																	
6P-1000 8P-500	3	5 <sup>1</sup> / <sub>2</sub>	140	10 <sup>13</sup> / <sub>16</sub>	275	5 <sup>5</sup> / <sub>8</sub>	25	18	457	7 <sup>1</sup> / <sub>4</sub>	184	8 <sup>1</sup> / <sub>2</sub>	216	7	178	7	178
4P-3000																	
6P-1500 8P-750	3	7 <sup>7</sup> / <sub>8</sub>	200	12 <sup>3</sup> / <sub>4</sub>	324	1	25	22 <sup>1</sup> / <sub>2</sub>	572	10 <sup>1</sup> / <sub>4</sub>	260	10 <sup>1</sup> / <sub>2</sub>	267	8 <sup>7</sup> / <sub>8</sub>	225	8 <sup>7</sup> / <sub>8</sub>	225
4P-5000																	
6P-2500 8P-1250	3	7 <sup>7</sup> / <sub>8</sub>	200	12 <sup>13</sup> / <sub>16</sub>	325	1	25	24	610	10 <sup>1</sup> / <sub>4</sub>	260	10 <sup>1</sup> / <sub>2</sub>	267	8 <sup>7</sup> / <sub>8</sub>	225	8 <sup>7</sup> / <sub>8</sub>	225
4P-10000 + 6P-5000 + 8P-2500 +	3	12 <sup>5</sup> / <sub>8</sub>	321	15 <sup>1</sup> / <sub>2</sub>	394	1 <sup>1</sup> / <sub>4</sub>	32	29 <sup>3</sup> / <sub>4</sub>	756	15 <sup>5</sup> / <sub>8</sub>	397	13	330	10 <sup>3</sup> / <sub>4</sub>	273	2	51

\*Bolt Size +Use Figure 2 for dimensions Note: Dimensions and data subject to change without notice.

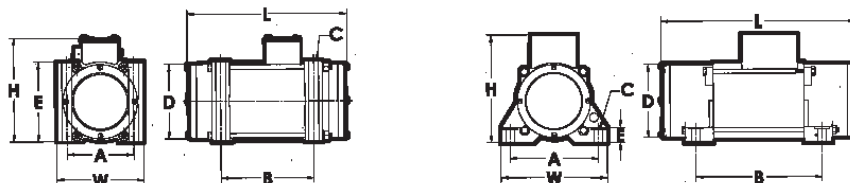

# Heavy Duty Electric Vibrators

## TECHNICAL DATA

Model	Phase	1 phase			3 phases			Force (Impact) lbs./N <sup>+</sup>						**dB	Weight***	
		Amperes at Volt			H.P.	Min.		Max.				lbs.	kg.			
		115/230	230/460	575		lbs.	N	lbs.	N	lbs.	N					
<b>3600 VIBRATIONS PER MINUTE — 2 POLE</b>																
2P-75	1 & 3	.5/25	.2/1	—	1/5	50	222	75	334	100	445	60	12	5.4		
2P-100	1 & 3	.5/25	.2/1	—	1/5	100	445	150	667	175	778	63	12	5.4		
2P-150	1 & 3	1.8/9	.6/3	.12	1/4	130	578	175	778	250	1112	63	26/25	11.8/11.3		
2P-200	1 & 3	3/1.5	1/5	.45	1/3	180	801	325	1446	400	1779	62	35/33	15.9/15		
2P-450, 450S	1 & 3	5/2.5	1.2/6	.5	1/2	100	445	680	3025	1100	4893	64	55 (46)	25 (21)		
2P-800	1 & 3	8/4	2/1	.8	3/4	100	445	1000	4448	1750	7784	70	85/80	38.6/36.3		
2P-1700	3	—	3/1.5	1.2	1 1/2	600	2669	1500	6672	2500	11120	72	90	40.8		
2P-2500	3	—	5/2.5	3.0	2	500	2224	1650	7339	3000	13344	73	105	47.6		
2P-3500*	3	—	5/2.5	1.7	2	500	2224	1650	7339	3000	13344	75	105	47.6		
2P-4500*	3	—	5.5/2.8	3.1	2	2200	9786	3450	15346	5000	22240	76	110	49.9		
2P-5500*	3	—	8/4	3.2	3	500	2224	3300	14678	5600	24909	72	220	99.8		
*Special Bearings for Concrete Applications.																
<b>1800 VIBRATIONS PER MINUTE — 4 POLE</b>																
4P-350	1 & 3	4/2	1/5	.3	1/4	50	222	100	445	200	890	60	36/34	16.3/15/14		
4P-600	1 & 3	4.2/2.1	1/5	.3	3/8	150	667	250	1112	400	1779	60	40/38	18.1/17.2		
4P-700	1 & 3	6/3	1.2/6	.6	1/2	100	445	300	1334	500	2224	63	60/55	27.2/24.9		
4P-1000	1 & 3	6.2/3.1	1.2/6	.6	1/2	250	1112	500	2224	800	3558	63	54/43	24.6/19.6		
4P-1400	1* & 3	*/*	3.5/1.8	1.2	1	400	1779	700	3114	1100	4893	70	100/95	45.5/43.1		
4P-2000	3	—	4/2	1.6	1 1/2	750	3336	1100	4893	1500	6672	72	98	44.5		
4P-3000	3	—	6/3	2.4	2 1/2	1500	6672	2200	9786	3000	13344	74	200	90.7		
4P-5000	3	—	6/3	2.4	3	1550	6894	3900	17347	4500	20016	75	225	102.1		
4P-10000	3	—	10/5	4	5	4560	20283	8000	35584	10000	44480	76	460	208.7		
<b>1200 VIBRATIONS PER MINUTE — 6 POLE</b>																
6P-300	1 & 3	4/2	1.2/6	.5	1/4	50	222	125	556	250	1112	60	60/55	27.2/24.9		
6P-500	1 & 3	4.2/2.1	1.6/8	.5	1/4	100	445	200	890	400	1779	60	62/58	28.1/26.3		
6P-1000	3	—	4/2	1.6	1	350	1557	450	2002	700	3114	72	98	44.5		
6P-1500	3	—	6/3	2.4	1 1/2	700	3114	1000	4448	1500	6672	74	200	90.7		
6P-2500	3	—	6/3	2.4	2	700	3114	1250	5560	2000	8896	75	225	102.1		
6P-5000	3	—	10/5	4	3	2000	8896	3000	13344	4500	20016	76	460	208.7		
<b>900 VIBRATIONS PER MINUTE — 8 POLE</b>																
8P-500	3	—	4/2	1.6	1/4	180	801	250	1112	400	1779	65	98	44.5		
8P-750	3	—	6/3	2.4	1/4	400	1779	575	2558	800	3558	74	200	90.7		
8P-1250	3	—	6/3	2.4	1	400	1779	700	3114	1250	5560	75	225	102.1		
8P-2500	3	—	10/5	4	1 1/2	1150	5115	1800	8006	2500	11120	76	460	208.7		

\* Consult factory for availability Note: Most Vibrators available in both 50 & 60 cycles. 115 to 575 volt.

\*\* Decibel at 3' (1 meter) on A scale

\*\*\* First figure 1 phase units, the other 3 phase units

+N = Centrifugal Force in Newton

Note: Dimensions and data subject to change without notice.

The VIBCO Engineer is at your disposal for supplying you with the recommendations, engineering data, mounting instructions and installation drawings. Our Field Engineers have a thorough knowledge built up through years of practical experience in applied vibration. All recommendations are free and without obligation.

**NOISELESS — AS LOW AS 60dB AT 3' ON A-SCALE**

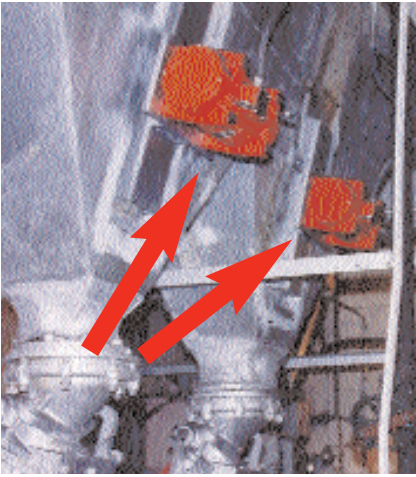

Two Model 2P-800's feeding screw conveyor

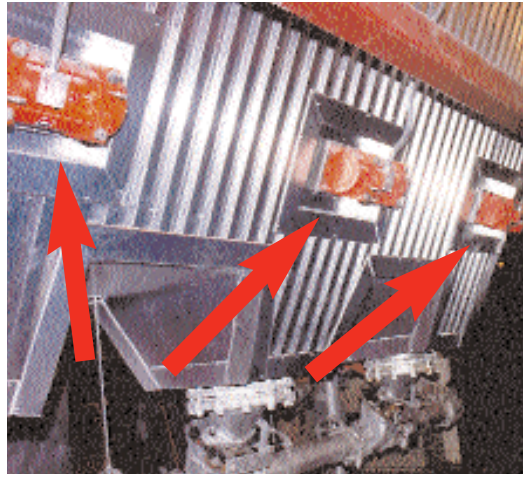

Model 2P-3500 on multiple chemical bins

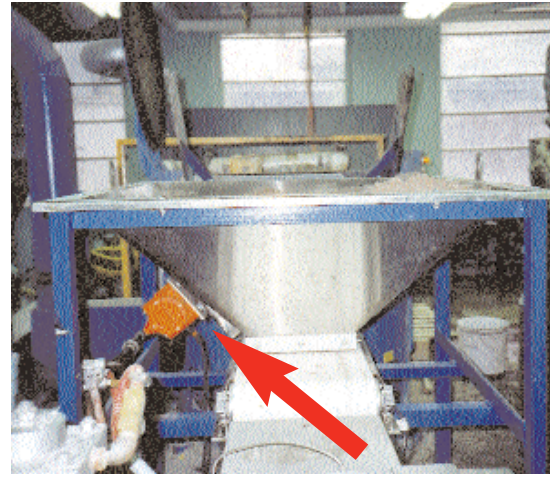

Model 2P-150 on hopper feeding conveyor belt

## Vibrators In Action

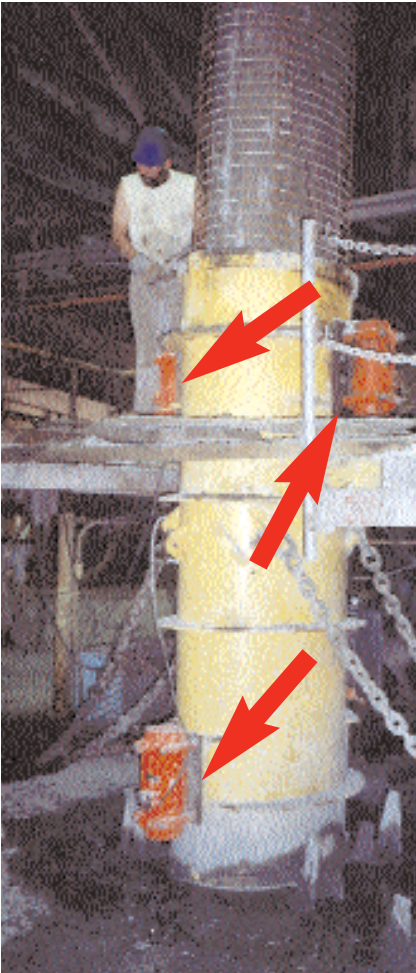

Model 2P-4500 on pipe form

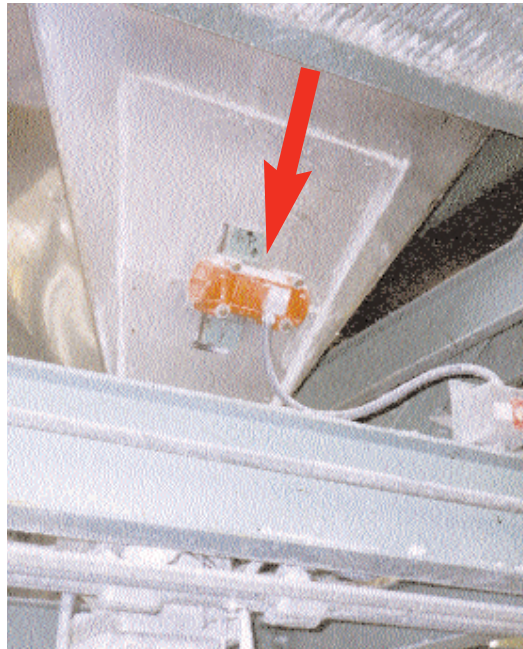

Model 2P-1700 on gypsum board



Two Model 4P-5000's on feeder

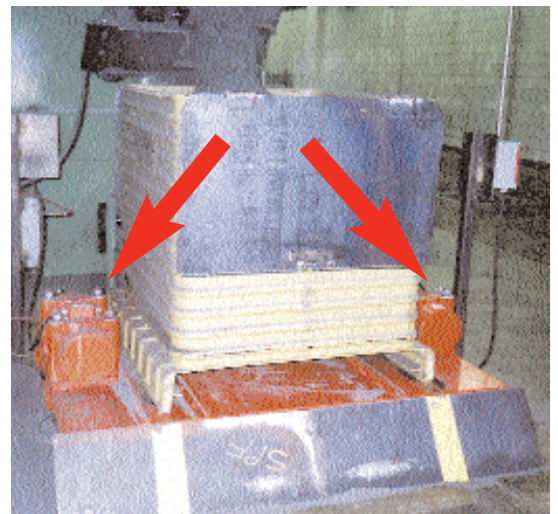

Two Model 4P-3000's on gaylord packing table

Model 2P-200 on transfer bin

**Call a VIBCO  
Application  
Engineer  
for your  
application  
today!**

# Model SPR, CE, Small



SPR-20 and -21



SPRT-21



SPWT-21, SPWT-60 and -80

## MODEL SPR Small Impact Line

### FEATURES:

- **COMPACT**
- **NOISELESS**
- **CONTINUOUS DUTY**
- **LIGHTWEIGHT**
- **STOPS & STARTS EASILY**
- **CONVENIENT - 115 VOLT PLUG IN**

### TECHNICAL DATA

Model	Force Impact		V. Volt	Amps	Ph.	Speed V.P.M.	Enclosure	Adjustable Speed Option	Wt.		dB*
	lbs.	N							lbs.	kg.	
CE-60***	100	445	115	.3	1	3600	Watertight	Yes	8**	3.6	65
SPR-20	15	67	115	.5	1	1600	Open	Yes	3	1.4	45
SPR-21	20	89	115	.8	1	3200	Open	Yes	3	1.4	48
SPR-40	25	111	115	1.4	1	1600	Tot. Encl. & Fan Cooled	Yes	7	3.2	45
SPR-60&60HD	60	267	115	1.5	1	3200		Partly	7	3.2	48
SPR-80&80HD	80	356	115	1.7	1	3200		Partly	7	3.2	50
SPRT-21	20	89	115	1.4	1	3200	Tot. Encl.	Yes	3	1.4	45
SPRT-60&60HD	60	267	115	1.5	1	3200	Tot. Encl.	Partly	7	3.2	48
SPRT-80&80HD	80	356	115	1.7	1	3200	Tot. Encl.	Partly	7	3.2	50
SPWT-21	20	89	115	1.4	1	3200	Watertight	Yes	7	3.2	45
SPWT-60	60	267	115	1.5	1	3200	Watertight	Partly	7	3.2	48
SPWT-80	80	356	115	1.7	1	3200	Watertight	Partly	7	3.2	50

N = Centrifugal force in Newton \*\*5 lbs. Aluminum \*dB at 3' (1 meter) on A scale  
 \*\*\*CE in aluminum or cast iron housings ‡Most units also available in 230 volt.  
 Note: Dimensions and data subject to change without notice.

VIBCO's Model SPR, SPRT, SPWT and CE electric motor vibrators are specially developed for the thousands of applications where only a small shake is necessary, but big vibrator reliability is a must. For activating small hoppers, screens, chutes, tables, filling machines, etc. Controlled flow is obtained on all types of materials, including fine powders, flakes, pills, bottle caps and jars, etc. Speed and force can be adjusted on most models with simple rheostats or speed adjusters.

Completely noiseless operation (no more sound than a fan motor) makes these vibrators desirable in applications where noise is irritating or fatiguing for the employee. Most units available in 230 volt 50 or 60 cycles.

Rugged construction permits continuous or repeated start and stop operation in any position.

SPR-60HD, 80HD and SPRT-60HD, 80HD and CE are heavy duty units with oversized bearing and cast iron end bell instead of aluminum for extra long life.

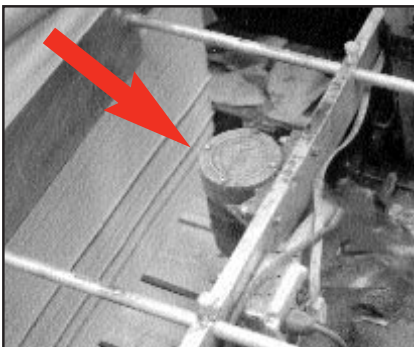

SPR-60HD lining sheet paper in print shop.

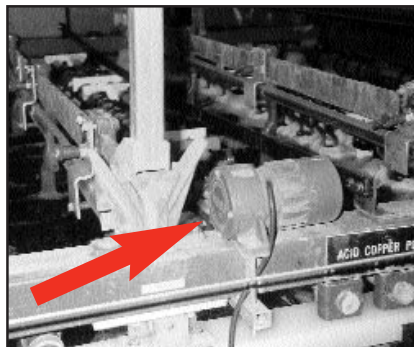

SPR-80 on circuit board plating tank.

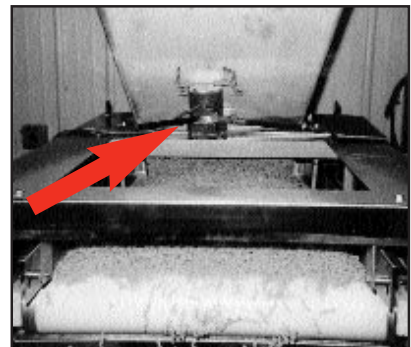

SPR-60 preventing hangups in hopper with pasta feeding weigh belt feeder.

# Impact Electric Vibrators



**SPR-40, -60, -80  
SPR-60HD and 80HD**



**SPRT-60 and -80**



**CE-60**

## DIMENSIONS

Model	A inch / mm		B inch / mm		C* inch / mm		L inch / mm		W inch / mm		H inch / mm		D inch / mm		E inch / mm		F inch / mm	
CE-60	3 <sup>5</sup> / <sub>8</sub>	92	1 <sup>5</sup> / <sub>16</sub>	33	1/4	6	6 <sup>1</sup> / <sub>16</sub>	154	4 <sup>3</sup> / <sub>8</sub>	111	3 <sup>1</sup> / <sub>4</sub>	83	3	76	7/16	11	—	
SPR-20, 21, SPRT-21	4	102	—		3/8	10	5	127	5	127	3 <sup>1</sup> / <sub>2</sub>	89	3 <sup>1</sup> / <sub>2</sub>	89	7/16	11	4	102
SPR-40, 60, 80 & HD	5	127	—		3/8	10	7	178	6	152	4 <sup>1</sup> / <sub>4</sub>	108	4	102	1/2	13	5 <sup>7</sup> / <sub>8</sub>	149
SPRT-60, 80 & HD	5	127	—		3/8	10	5 <sup>1</sup> / <sub>2</sub>	140	6	152	4 <sup>1</sup> / <sub>4</sub>	108	4 <sup>3</sup> / <sub>16</sub>	106	1/2	13	4 <sup>1</sup> / <sub>2</sub>	114
SPWT-21, 60, 80	4 <sup>3</sup> / <sub>4</sub>	121	2 <sup>3</sup> / <sub>4</sub>	70	3/8	10	5 <sup>3</sup> / <sub>8</sub>	137	5 <sup>1</sup> / <sub>2</sub>	140	6 <sup>1</sup> / <sub>2</sub>	165	4 <sup>1</sup> / <sub>2</sub>	114	5/8	16	—	

\*Bolt Size Note: Dimensions & data subject to change without notice.

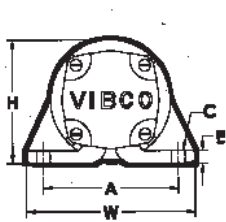

SPR & SPRT

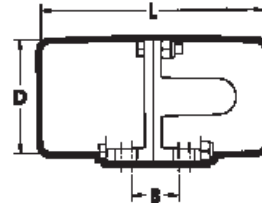
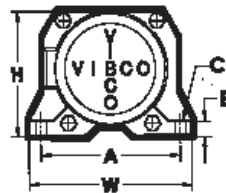
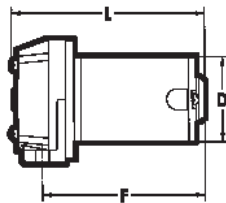

CE

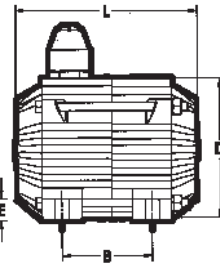
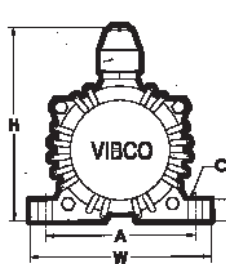

SPWT

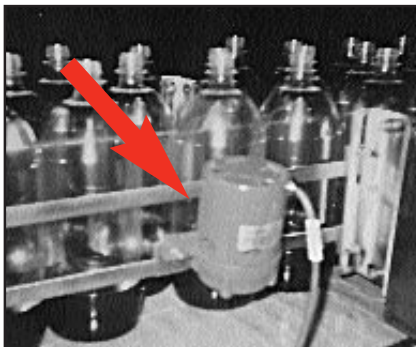

SPR-20 prevents plastic bottles from accumulating and sticking on conveyor belt.



SPR-60 on filling machine.

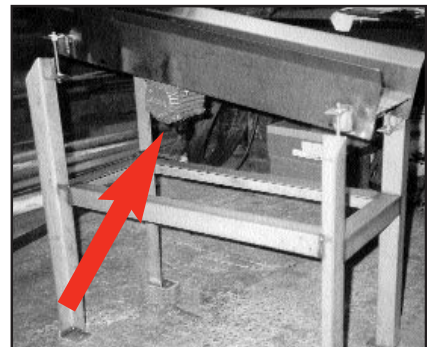

SPWT-80 on screen feeder.

# Model US

# 115/230 Volt High Frequency Electric



Ask for Cat. #8401 or 0103

## MODEL US

- FEATURES:**
- HIGH SPEED
  - RUGGED
  - SPEED ADJUSTABLE
  - 115 VOLT PLUG IN

VIBCO's Model US High Frequency line are 115 volt single phase motors with low amperage draw. They can be plugged into any light outlet or operated from field generators. All units are speed adjustable with rheostat or electronic speed controls. US-900 and 1600 have adjustable eccentrics. The US line is, due to the high frequency, rated for intermittent operation. 230 volt available on most models. Consult factory.

### HIGH FREQUENCY VIBRATORS IDEAL FOR ALL CONCRETE WORK

#### FOR CONCRETE PRODUCT

- Faster pouring
- Less cement needed
- Greater density
- Smoother finish
- Faster form removal

#### FOR VIBRATOR

- Totally enclosed
  - High impact
  - Light weight
  - Assortment of brackets available
- See page 35 & 36.

#### Casting Concrete.

Model US is ideal both at the precast plant on tables, vaults, septic tanks, patio blocks, steps, etc., and at the construction site giving "architectural" finishes and fireproofing to poured-in-place walls and columns. Ask for Catalog 0103. Model US-900, the most popular unit for septic tanks, burial vaults, step forms, for architectural surface finish and fire proofing columns, casting tables for up to 300 lbs. of product. US-1600 the problem solver - for similar applications as the US-900. See page 35 and 36 for different brackets. Ask for Catalog 8401.

**Bins & Weigh-Batchers.** The US-450 has become the standard unit throughout the industry for weigh-batchers. The US-700, US-900 and US-1600 for moving powdery and sticky materials in bins and chutes.

**Fatigue and Test Tables.** For verifying integrity of electric circuits, removing dangerous residues, detect marginal connections.

### TECHNICAL DATA

Model	Wt.	Force N	Amps.**	Volts	Ph.	Max. Speed	dB*	Weight lbs.	Duty Cycle
US-100	100	445	.65	115 AC-DC	1	10000	78	4 1.8	Int.
US-450	450	2002	2.0	115 AC-DC	1	9500	80	13 6.9	Int.
US-700	700	3115	2.5	115 AC-DC	1	9500	80	20 9.1	Int.
US-900	900	4004	4.5	115 AC-DC	1	10000	85	18 8.2	Int.
US-1600	1600	7118	6.0	115 AC-DC	1	9500	85	20 9.1	Int.
DC-20	20	89	3.7	8 & 12 DC	1	3500	88	3 1.4	Cont.
DC-50	50	225	8	12 & 24 DC	1	3500	71	6 2.72	Cont.
DC-60	50	267	9	12 & 24 DC	1	3500	68	9 3.8	Cont.
DC-100	100	445	12	12 & 24 DC	1	4000	72	4 1.8	Cont.
DC-200	300	1334	14	12 & 24 DC	1	4000	73	8 3.6	Cont.
DC-300	350	1567	16	12 & 24 DC	1	4000	74	9 4	Cont.
DC-450	400	1780	22	12 & 24 DC	1	7000	75	17 7.7	Cont.
DC-600	450	2005	18	12 & 24 DC	1	4000	73	12 5.5	Cont.
DC-700	700	3115	25	12 & 24 DC	1	6000	75	20 9.1	Int.
DC-800	600	2688	30	12 & 24 DC	1	6000	78	20 9.1	Special
DC-1600	1000	4450	32	12 & 24 DC	1	5000	82	30 13.6	Special
DC-3500	2500	15572	60	12 & 24 DC	1	4000	70	36 16.3	Special

Note: The frequency will vary with the load. \*Decibel on A-scale at 3' (1 meter) N=Centrifugal force in Newton.

\*\*Amps shown for 12 volt DC (24 volt amps 1/2 of 12 volts) \*\*\*230 Volt available on most US-Models Note: Dimensions and data subject to change without notice.



# Model DC 12 Volt Battery Operated

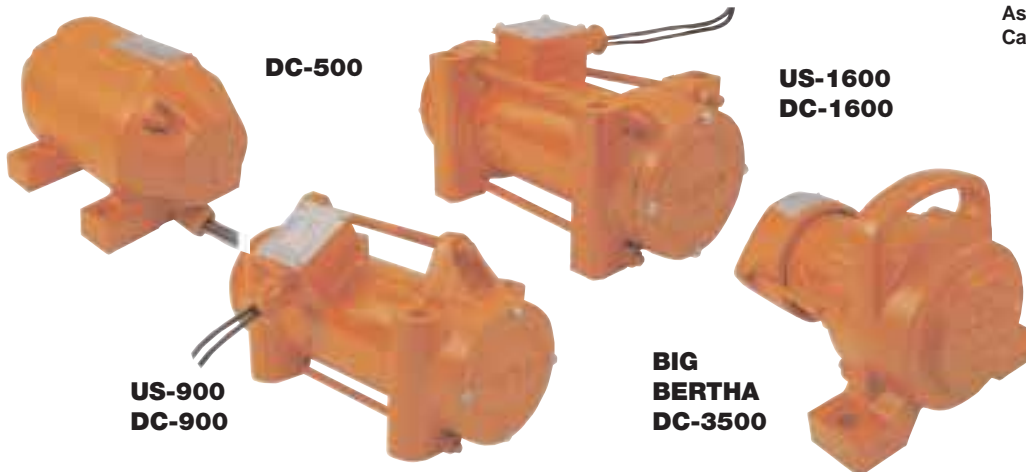

Ask for  
Cat. #0101

Ask for  
Cat. #9511

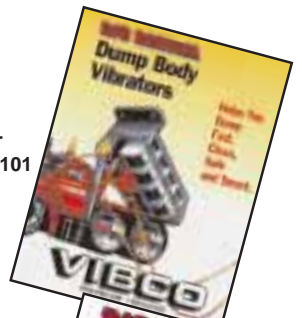

## MODEL DC - 12 Volt DC Battery Operated

VIBCO's 12 Volt DC Vibrators are ideal for field or mobile applications. Cleans and aids flow of material from bins and chutes. Insures fast dump of trucks, highway equipment, fertilizer trailers, ready mix trucks, spreaders and concrete pumps.  
 DC-20 small spreaders & hoppers.  
 DC-100 hoppers etc. up to 1-1/2 yards.  
 DC-200 and DC-300 small work horse for landscape equipment & trailer mounted concrete pumps.  
 DC-500 the choice for truck mounted concrete pumps. Watertight & O-ring sealed for power washdown. DC-60 for trailer mounted pumps.

DC-450 popular on tailgate spreaders, small hoppers, fertilizer and bulk feed trucks, mobile bins and hoppers.  
 DC-700 has more power per pound than any other vibrator, excellent for use on screening plants, chutes, etc.  
 DC-900 and DC-1600 for hopper spreaders, large mobile bins, concrete spreaders.  
 DC-3500 on dump trucks, moving loam and other sticky materials, highway spreaders and concrete placers and pavers, screens and larger storage bins.

ASK FOR CATALOGS  
#0101, #9511 and #9112.

Ask for  
Cat. #9112

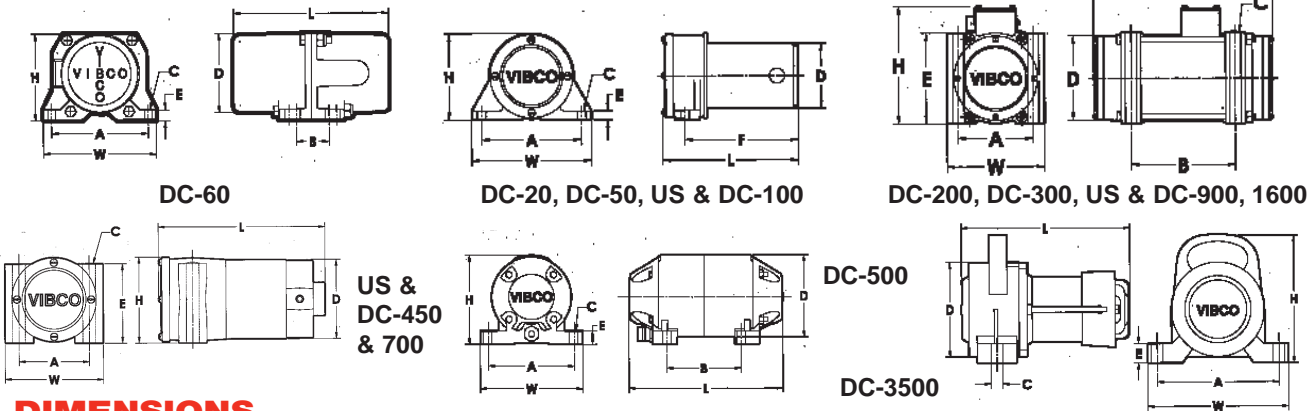

### DIMENSIONS

Model	L inches	W inches	H inches	A inches	B inches	C inches	D inches	E inches
DC-20	5	187	4 1/2	88	4	102	—	7 1/2
DC-20	5 1/4	142	4	84	4	102	—	7 1/2
DC-20	6 1/4	182	4 1/2	114	3 1/4	84	1 1/2	30
US-100, DC-100	6 1/4	171	4	102	4	127	—	7 1/2
DC-200	8 1/4	212	4 1/2	108	4	79	2 1/4	148
DC-300	8	229	4 1/2	106	5	79	2 1/4	146
US-450, DC-450	11 1/4	218	4 1/2	124	4 1/2	105	—	12
US-700, DC-700	7 1/4	187	5 1/2	142	5 1/4	122	—	12
DC-900	8	229	4 1/2	108	5 1/4	122	4 1/2	114
US-900, DC-900	11 1/4	232	4 1/2	148	4 1/2	108	—	12
US-1600, DC-1600	11 1/4	238	4 1/2	142	4 1/2	114	7	178
DC-3500	12	308	10	224	8	228	8 1/2	218

\*Bolt Size Note: Dimensions and data subject to change without notice.

# Model PX Explosion Proof Electric Vibrators



## MODEL PX - Explosion Proof

### FEATURES:

VIBCO now offers the first American made explosion proof motor vibrator in NEMA 42, 48, 56 and 182 frame sizes.

Model 2PX-200 and 4PX-350 in 42 frame and 2PX-450 and 4PX-700 in 48 frame, are supplied in 3 phase and single phase in Class 1 Group D, Div. 1 & 2.

Model 4PX-2000 in 56 frame and 4PX-5000 in 182 frame, are supplied in 3 phase, Class 2 Group F & G, Div. 1 & 2.

The eccentrics have 6 adjustable force settings for easy adjustment to match impact force to applications.

Oversized roller bearings in Models 4PX-2000 & 4PX-5000 assure extra long life. Accessible lubricator nipples make them easy to lubricate. The other models have ball bearings which are pre-lubricated for life.

VIBCO's Heavy Duty Line is classified as Class II Div. 2.

### TECHNICAL DATA

Model	Ph.	Amp.	Volt**	V.P.M.	Force (Impact) lbs./N Adjustable						dB***	Wt.	
					lbs.	Min.	N	lbs.	Norm.	N		lbs.	Max.
2PX-200	*1 3	3.4/1.7 1/1.5	*115/230* 230/460	3600	150	667	300	335	450	2002	60	20	9.1
2PX-450	1 3	5/2.5 1.6/8	115/230 230/460	3600	110	489	450	2002	900	4004	62	56	25.5
4PX-350	*3 *3	3.4/1.7 1/1.5	*115/230* *230/460	1800	100	445	200	390	300	1335	62	20	9.1
4PX-700	1 3	6/3 1.4/7	115/230 230/460	1800	300	1335	500	2225	700	3114	64	58	26.4
4PX-2000	3	3.6/1.8	230/460	1800	625	2781	1200	5340	2000	8900	72	130	59
4PX-5000	3	5.2/2.6	230/460	1800	1700	7565	4800	21360	6500	29250	75	240	109

\*Consult factory for availability. \*\* 575 Volt also available on most models. \*\*\*dB at 3' (1 meter) on A-scale.

### DIMENSIONS

Model	inch	L	mm	inch	W	mm	inch	H	mm	inch	A	mm	inch	B	mm	inch	C*	mm	inch	D	mm
2PX-200	14 <sup>7</sup> / <sub>8</sub>		378	10 <sup>1</sup> / <sub>8</sub>		257	5 <sup>1</sup> / <sub>4</sub>		133	5 <sup>1</sup> / <sub>2</sub>		140	11 <sup>3</sup> / <sub>4</sub>		298	1 <sup>1</sup> / <sub>2</sub>		13	4 <sup>1</sup> / <sub>2</sub>		114
2PX-450	14 <sup>1</sup> / <sub>2</sub>		368	11 <sup>1</sup> / <sub>4</sub>		286	6 <sup>1</sup> / <sub>8</sub>		156	6 <sup>5</sup> / <sub>8</sub>		168	9 <sup>5</sup> / <sub>8</sub>		244	5 <sup>5</sup> / <sub>8</sub>		16	5 <sup>1</sup> / <sub>2</sub>		140
4PX-350	16 <sup>7</sup> / <sub>8</sub>		429	10 <sup>1</sup> / <sub>8</sub>		257	5 <sup>1</sup> / <sub>4</sub>		133	5 <sup>1</sup> / <sub>2</sub>		140	11 <sup>3</sup> / <sub>4</sub>		298	1 <sup>1</sup> / <sub>2</sub>		13	4 <sup>1</sup> / <sub>2</sub>		114
4PX-700	14 <sup>1</sup> / <sub>2</sub>		368	11 <sup>1</sup> / <sub>4</sub>		286	6 <sup>1</sup> / <sub>8</sub>		156	6 <sup>5</sup> / <sub>8</sub>		168	9 <sup>5</sup> / <sub>8</sub>		244	5 <sup>5</sup> / <sub>8</sub>		16	5 <sup>1</sup> / <sub>2</sub>		140
4PX-2000	18		457	13 <sup>7</sup> / <sub>8</sub>		352	11 <sup>1</sup> / <sub>8</sub>		283	10		254	13 <sup>11</sup> / <sub>16</sub>		348	1		25.4	7 <sup>7</sup> / <sub>8</sub>		200
4PX-5000	20 <sup>1</sup> / <sub>4</sub>		521	15 <sup>7</sup> / <sub>8</sub>		403	14 <sup>1</sup> / <sub>2</sub>		368	13		330	17		432	1		25.4	10 <sup>3</sup> / <sub>4</sub>		273

\*Bolt size to be used Note: Dimensions and data subject to change without notice.

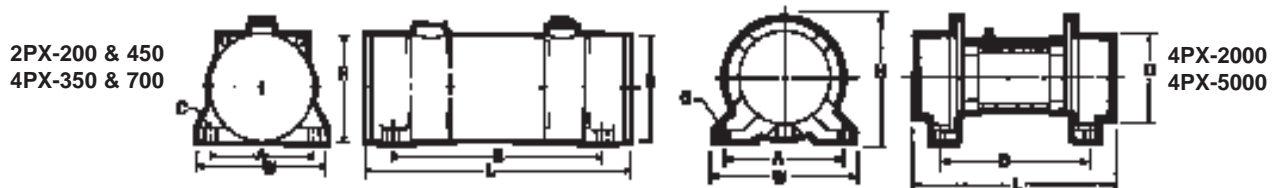

# Model SFC - End Mount Model FC - Fan Cooled Electric Vibrators

## FEATURES:

- **TOTALLY ENCLOSED**
- **CONTINUOUS DUTY**
- **ADJUSTABLE ECCENTRICS**
- **OUTSIDE FAN-COOLED FOR HIGH HEAT APPLICATIONS**
- **CAN TAKE ANY NUMBER OF STARTS & STOPS**
- **SINGLE & 3 PHASE MODELS**



SFC-100



FC-400

### VIBCO'S POPULAR SFC VIBRATORS ARE:

Favorite for use indoors and outdoors where a lightweight, totally enclosed vibrator is required to keep materials moving to automatic production machines, in small to medium size bins, chutes, screens, etc. Ease of mounting, low amperage draw, makes these units popular for O.E.M. applications.

MODEL FC with high capacity external fan and heat resistant winding makes the FC units ideal for applications where ambient temperature is high or heat is transferred through bin skin. Consult VIBCO for application limits.

## TECHNICAL DATA

Model	Ph.	Amp.	Volt***	V.P.M.**	Force (Impact) lbs./N Adjustable						dB*	Wt.	
					lbs.	Min.	N	lbs.	Norm.	N		lbs.	Max.
SFC-100	1	4.2/2.1	115/230	3600	60	267	100	445	150	667	60	25	11.3
	3	1.6/0.8	230/460									21	9.5
SFC-300	1	4.2/2.1	115/230	3600	100	445	220	979	300	1335	62	27	12.2
	3	1.6/0.8	230/460									23	10.4
FC-100	3	4.2/2.0	115/230	3600	100	445	220	979	300	1335	62	34	15.4
	3	1.6/0.8	230/460									31	14.1
FC-400	1	4.2/2.1	115/230	3600	150	667	300	1335	450	2002	64	35	15.9
	3	1.6/0.8	230/460									32	14.5

\* dB at 3' (1 meter) on A-scale      N = Centrifugal force in Newton  
 \*\* 1800 V.P.M. (Vibrations Per Minute) available  
 \*\*\* 575 Volt available  
 Note: Dimensions and data subject to change without notice.

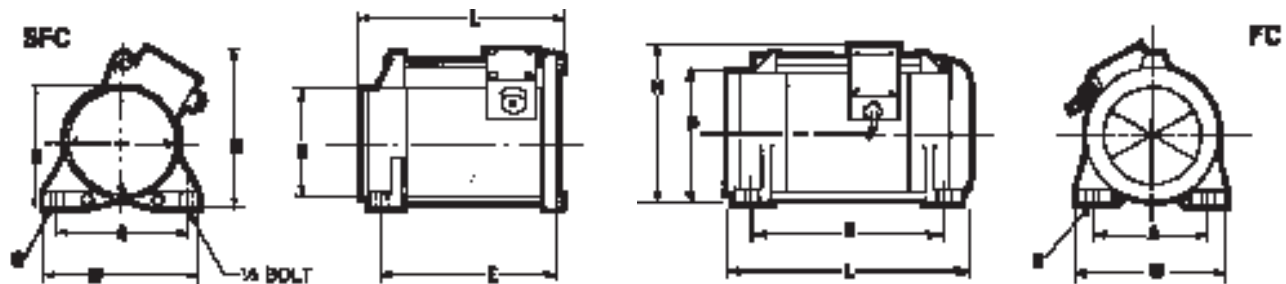

## DIMENSIONS

Model	L inch / mm		W inch / mm		H inch / mm		A inch / mm		B inch / mm		C* inch / mm		D inch / mm		E inch / mm	
SFC	8 1/4	210	6 1/2	165	6 3/4	171	5 1/4	133	—	1/2	12	4 1/2	114	7	178	
FC	10	254	7 1/2	191	6 3/4	171	5 1/4	133	7 1/2	190	1/2	12	5 1/8	130	—	

\*Bolt size to be used      Note: Dimensions & data subject to change without notice.

# Mounting Brackets



Weigh Batcher with Model 55-1-1/2 Piston



Septic Tank with US-900 & Wedge Bracket



US-900 with Wedge Bracket on precast mold



Mounting Plates & Channels



UWF-3 Heavy Duty Wedge Bracket



UWF-1 - Female Bracket for Wedge Form Bracket



Burial Vault — US 450T with Pin Bracket

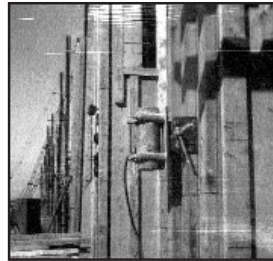

US-900 with wooden form clamp on column

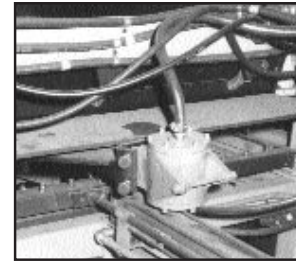

SVR-5500 with Shoe Bracket casting panels



Pin-Bracket with UPF-Female

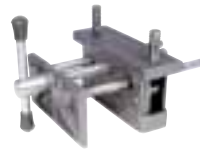

Wood-Form Bracket



Adapter Bracket-For-SB Shoe Bracket



SVRLS-5500 on precast form

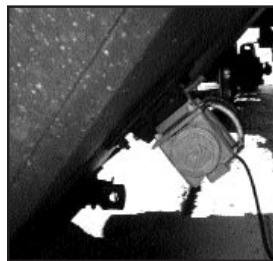

Electrical 2P-450 on Railroad Car Wedge

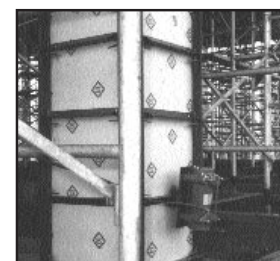

US-1600 with "Clamp-On" bracket on wooden form with steel reinforcing



Lug-Bracket - LC-1    Lug-Bracket - LC-2



Rail-Road Car Wedge Bracket



Clamp-On Bracket

# Mounting Brackets

STANDARD		Mounting Bracket	Clamp Block	Car Shaker & Form Bracket	Car Shaker Wedge Bracket	Adapter Plate	Wedge Type Form Bracket	Pin Form Bracket	Wooden Form Bracket
Model				Clamp-On Bracket	Wedge Type Bracket	Form & Bin SB-Shoe Bracket	UWF-Female	UPF-Female	
2P-75		VMM-11 (2)		VMC-81 (8)					
2P-100		VMM-111 (2)		VMC-82 (8)					
2P-150		VMM-12 (2)		VMC-83 (8)					
2P-200, 4P-350,		VMM-2 (7)		VMC-2 (18)	VMW-2 (16)	VMH-2 (7)			VMF-2 (18)
2P-450, 4P-700*									
4P-1000*,	1 ph	VMM-4 (8)		VMC-4 (20)	VMW-4 (18)	VMH-4 (10)			VMF-4 (20)
6P-300*, 6P-500*	3 ph	VMM-3 (8)		VMC-3 (20)	VMW-3 (18)	VMH-3 (10)			VMF-3 (20)
2P-800	1 ph	VMM-61 (10)		VMC-61 (22)	VMW-61 (20)	VMH-61 (10)			
	3 ph	VMM-5 (9)		VMC-4 (22)	VMW-5 (20)	VMH-5 (10)			
2P-1700	3 ph	VMM-6 (10)		VMC-6 (22)					
4P-1400	3 ph	VMM-6 (10)		VMC-6 (22)					
2P-2500, 2P-3500	3 ph	VMM-7 (11)		VMC-7 (24)					
2P-4500, 4P-2000	3 ph	VMM-6 (10)		VMC-6 (22)					
6P-1000	3 ph	VMM-6 (10)		VMC-6 (22)					
8P-500	3 ph	VMM-6 (10)		VMC-6 (22)					
2P-5500,		VMM-8 (16)							
4P-3000 & 5000									
6P-1500 & 2500		VMM-8 (16)							
8P-750 & 1200		VMM-8 (16)							
SPR, SPRT-20, 21,		SPM-1 (2)	C-2 (3)						
40, 60 & 80		SPM-2 (3)	C-2 (3)						
SPWT		SPWM (3)		SPWC (8)					
SCR-100, US-100									
& DC-100		UM-1 (2)	C-2 (3)						
SCR-200, US-450									
DC-450 & DC-700		UM-2 (4)	C-4 (4)			UA-1 (5)	UW-4* (8)	UW-1 (5)	
SCR-500		SCRM-2 (8)		SCRC-2 (20)	SCRW-2 (18)	SCRA-2 (10)			SCRF-2 (20)
SCR-1000		SCRM-1 (8)		SCRC-1 (20)	SCRW-1 (18)	SCRA-1 (10)			SCRF-1 (20)
SFC		SFCM (4)	C-4 (4)			SFCH (5)			
FC		FCM-1 (5)		FBB-1 (15)		FCH-1 (7)			USF-2 (15)
US-900, DC-900		UM-3 (6)		UC-1 (15)		UA-2 (7)	UW-2* (8)		USF-3 (15)
US-1600, DC-1600		UC-4 (6)		UC-2 (16)		UA-3 (7)	UW-3* (8)		
BB, BBS, FBS			C-1						
B, BV, BVS-130		BVM-1	C-2						
B, BV, BVS-190		BVM-2	C-2						
B, BV, BVS-250		BVM-3	C-2					BVP-5	
B, BV, BVS-320		BVM-4	C-3			BVH-4	BVT-4	BVP-4	BVF-4
B, BV, BVS-380		BVM-5	C-4			BVH-3	BVT-3	BVP-3	BVF-3
BVS-440/510		BVM-6	C-4	BVC-3		BVH-2	BVT-2	BVP-2	BVF-2
BVS-510F		BCM-61		BVC-2		BVH-21	BVT-21	BVP-21	BVF-21
BVS-570		BVM-7	C-4	BVC-1	BVW-1	BVH-1	BVT-1	BVP-1	BVF-1
V, VS-130		VSM-1	C-2						
VS-190		VSM-2	C-2				VST-3	VSP-3	
VS-250		VSM-3	C-2				VST-2	VSP-2	VSF-2
VS-320, V-320		VSM-3	C-3			VH-1	VST-2	VSP-1	VSF-1
VS-380, V-380		VSM-4	C-4			VH-2	VST-1		VSF-3
VS-510		VSM-5		VC-1		VH-3	VST-4		
CCF-2000		CCM-3		CCFC-3	CCFW-3	CCFH-3	CCW-2		
CCF-5000		CCM-1		CCFC-1	CCFW-1	CCFH-1	CCW-3		
CCL-5000				CCFC-2	CCFW-2	CCFH-2			
SVR-4000		SVM-1		SVC-1		SVA-1	SVH-1	SVP-1	SVF-1
SVR-5500				SVC-2	SVW-2		SVH-2		
SVRF-5500		SVM-2		SVC-4	SVW-4				
SVRL, SVRLS-5500,									
6500, 8000				CCFC-2	SVW-2	CCFH-1			
SVR-8000		SVM-2		SVC-3	SVW-3				
PF, HF-800, 1200,						SVA-6			
1500		PFM-1		PFC-1	PFW-1	PFA-1			
PF, HF-3000		PFM-2		PFC-2	PFW-2	PFA-2			

( ) INDICATES WEIGHT IN LBS. \*USE 1 PHASE BRACKETS FOR BOTH 1 & 3 PHASE UNITS.

## SPECIAL BRACKETS



Pipe-Brackets Available For Most Pipe Sizes

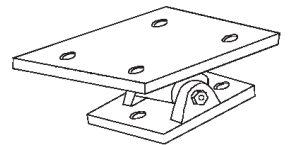

Linear Force Bracket for Feeders & Tables

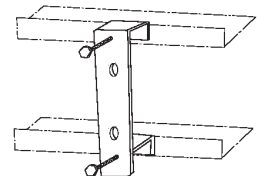

Special Clamp-On Bracket

**VIBCO**  
ENGINEERS  
will design  
special  
brackets  
for your  
applications

# Portable Lug-Type Vibrators

## ELECTRIC HYDRAULIC PNEUMATIC



**USL-900 & -1600**



**2PL-900 & -1600**



**HL-3000**



**LC-1**



**SVRL & SVRLS  
-5500, -6500 &  
-8000**



**SVRLS  
-4000**

**CCL-5000**



**LC-2**

Vibco's lug-type portable vibrator fits either the LC-1 or LC-2 lug bracket. They assure you of 100% vibration transfer and are an easy and inexpensive way to utilize one vibrator for many applications, from bin to bin, tote box to tote box, or concrete form to concrete form. Vibco offers a choice of electric, pneumatic, or hydraulic operation.

### TECHNICAL DATA

Electric Models	Phase	1 phase			3 phase			Force (Impact) lbs./N				Adjustable		Weight lbs. kg.	RPM
		Amperes at Volt			H.P.	Min.		Norm.		Max.		dB**			
		115/230	230/460	575		lbs.	N	lbs.	N	lbs.	N				
2PL-900	1 & 3	3/1.5	1/1.5	—	1/3	15	667	300	1335	450	2002	62	30	13.6	3600
2PL-1600	1 & 3	5/2.5	1.2/6	—	1/2	110	489	450	2002	900	4004	64	48	21.8	3600
USL-900	1	4.5/-	—	—	—	600	2669	900	4004	1100	4894	85	18	8.2	10000
USL-1600	1	5.0/-	—	—	—	1100	4894	1600	7118	1800	8008	85	20	9.1	9000

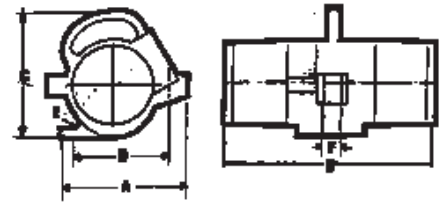

**2PL USL**

Pneumatic Models	Weight		80 PSI			90 PSI			100 PSI			CFM*	dB**
	lbs.	kg.	Force		Force		Force		Force				
	VPM*	lbs.	N	VPM*	lbs.	N	VPM*	lbs.	N	VPM*	lbs.		
SVRLS-4000	23	10.4	11500	3600	16000	12500	4000	17800	13500	4400	19500	40	78
SVRLS-5500	43	19.5	9000	4950	22000	10000	5500	24500	10500	6100	27100	54	78
SVRLS-6500	45	20.4	8800	5575	24800	9500	6500	28900	10000	7200	32000	58	80
SVRLS-8000	47	21.3	8500	7625	33900	8700	8000	35600	9500	9550	42500	62	82
SVRL-5500	37	16.8	9000	4950	22000	10800	5500	24500	10500	6100	27100	56	98
SVRL-6500	39	17.8	8800	5575	24800	9500	6500	28900	10000	7200	32000	60	98
SVRL-8000	41	18.6	8500	7625	33900	8700	8000	35600	9500	9550	42500	63	98

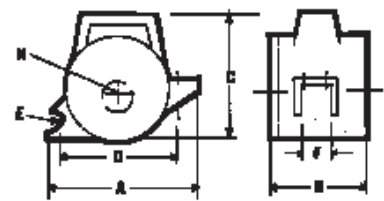

**SVRLS HL**

Hydraulic Models	Weight		Avg. PSI (max. 3000 PSI)	VPM*	GPM (max.)	Force		dB**
	lbs.	kg.				lbs.	N	
HL-3000	39	17.7	1000	5000	3.2	3400	15124	76

\*Frequency and air consumption will vary with load. \*\*dB a 3' (1 meter) on A scale N = Centrifugal force in Newton.

### DIMENSIONS

Model	A	B	C	D	E	F	H	J	K	Brackets
	inch/model	inch/model	inch/model	inch/model	inch/model	inch/model	inch/model	inch/model	inch/model	
2PL-900	7 1/8	12 3/8	7 1/8	5 1/2	1 25	—	—	—	1 1/16	LC-2
2PL-1600	9 1/2	11 5/8	7 1/8	6 5/8	1 25	1 1/16	27	—	—	LC-1
USL-900	7 1/2	11	7 1/4	4 3/4	3/4	7/8	22	—	—	LC-2
USL-1600	7 1/8	11	7 1/4	4 3/4	3/4	7/8	22	—	—	LC-2
SVRLS-4000	7 1/8	7 3/8	6 1/8	6	3/8	10	22	3/4	19	LC-2
SVRLS-5500, 6500 & 8000	9 1/2	24 1/8	9 1/4	7 3/4	1 25	1 1/4	32	3/4	19	LC-1
SVRL-5500, 6500 & 8000	9 1/2	24 1/8	9 1/4	7 3/4	1 25	1 1/4	32	3/4	19	LC-1
CCL-2000	7 1/8	8 1/8	7 1/4	5 1/8	3/4	3/4	19	4 1/8	105	3/4-NPT 7/4 197 LC-2
CCL-5000	9 3/8	8 3/8	8 3/8	8	1 25	1 1/4	32	5 1/4	133	1-NPT 8 1/2 216 LC-1
HL-3000	9 1/2	11 1/4	9 1/4	7 3/4	1 25	1 1/4	32	—	—	LC-1

Note: Dimensions and data subject to change without notice.

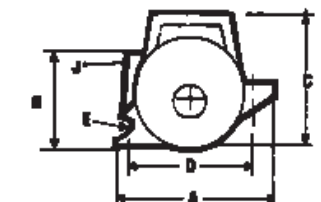

**CC**

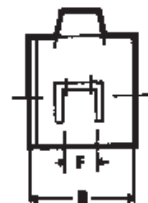

## TEST TABLES



US-TT

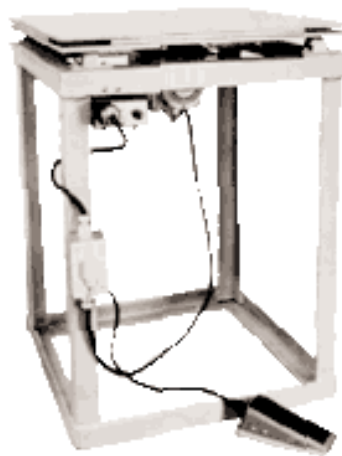

US-RD



Compaction Table

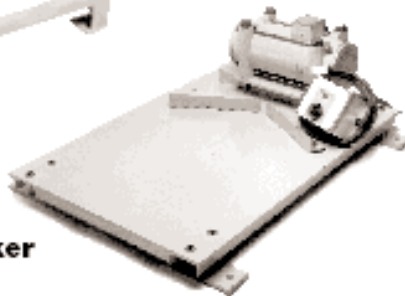

Drum Packer

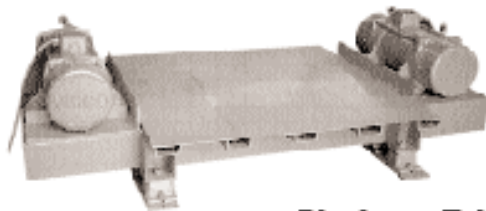

Platform Table

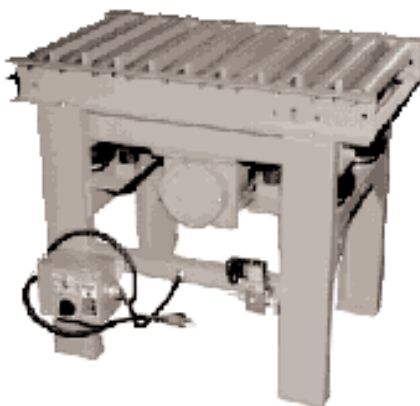

Grid Top Tables

# Vibrating Tables

## TEST TABLES

- Simulate Handling & Transportation Shocks
- Stop Costly Field Service Calls
- Handles Both Sub Assemblies & Complete Chassis
- Verify Integrity of Electric Circuits
- Removes Dangerous Residue
- Safe! No Harm to Sensitive Circuits
- Detect Marginal Connections
- Inexpensive Full Range Control



Ask for Catalog #7902.

VIBCO'S exclusive patented live top table design assures full, even vibration in all areas of the table top. Consistency and reliability of testing is assured. VIBCO'S wide choice of variable and constant frequency equipment gives the ultimate in low cost product reliability testing. Choose from standard 2' x 24" x 36" high tables or special tables designed for your particular requirements.

For more information ask for VIBCO'S complete test table brochure.

## COMPACTION TABLES

- Heavy duty for maximum loads
- Standard or custom made to specification
- Speed and impact adjustable

VIBCO'S compaction tables can be supplied with pneumatic or electric vibrators. Most are both speed and force adjustable. Heavy duty construction. "Built in" versatility means these tables can be used for packing, settling, casting concrete as well as fatigue testing.

Vibration is isolated from the frame with inflatable air mounts, rubber mounts or springs.

VIBCO engineers will design a table to meet your specific needs. Ask for bulletin No.7902.

## FLAT PLATFORM TABLE

- Low profile - as low as 2' from floor
- No vibration transfer to the floor

Vibrating platform with a working surface as low as 2' from floor. The platform table can be used under filling machines for packing drums and barrels. Low profile eliminates the need for raising machinery or breaking into the floor and makes loading and unloading heavy drums easier.

Packing more material per given volume saves costly space and lowers escalating transportation costs.

Ask for bulletin No.7902.

## GRID TOP TABLES

- Automatic operation
- Adaptable to any roller conveyor
- Lightweight yet strong

The VIBCO grid top table is designed to fit between the rollers of your conveyor. The load - laundry basket, drum or box - is rolled into position. Air mounts lift the grid top and take the load off of the rollers. The vibrators are activated and the load vibrated. Air mounts are deflated and the load is back on the conveyor ready to be moved along. All done in seconds without handling.

The VIBCO design uses strong lightweight rectangular tubing for more vibration transfer to the load.

For more information ask for our Foundry Bulletin and Bulletin No. 7902.



Ask for detailed brochure #7902.

# Flat Top Tables

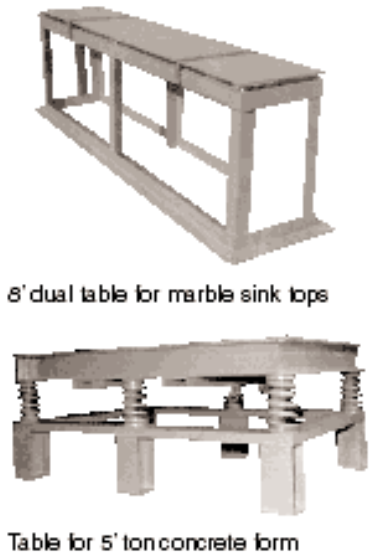
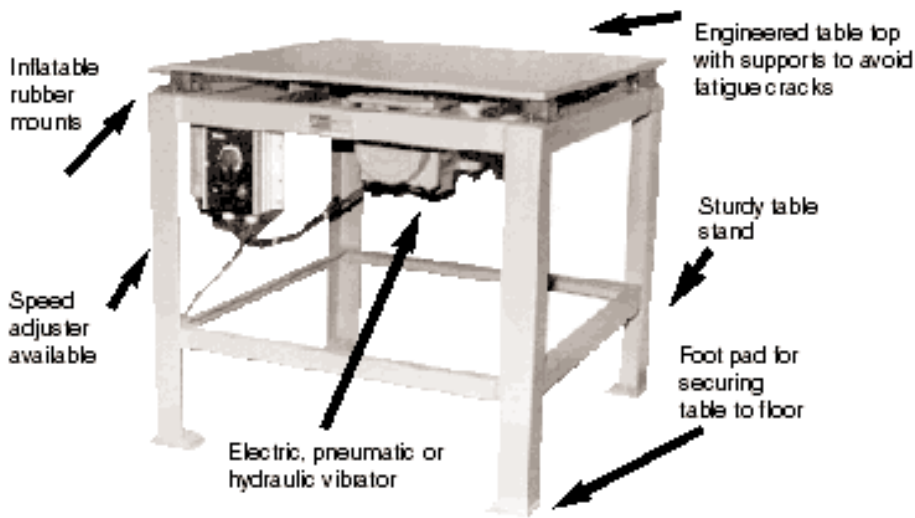

VIBCO's Flat Top Tables can be made to any specification and can handle weights from ounces to several tons. Let VIBCO's 40 years of experience help you.

# Quality Assurance Tables

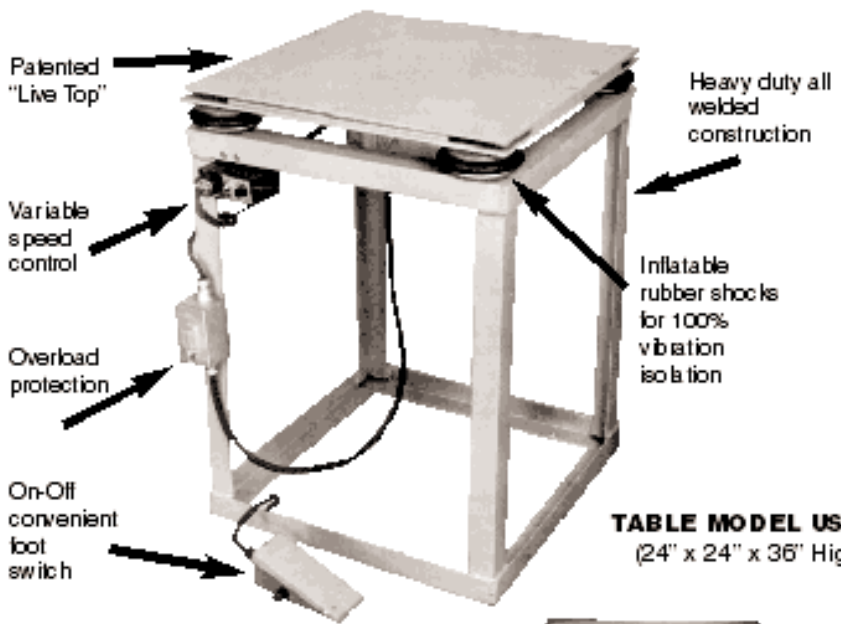

VIBCO's test tables for fatigue, quality assurance & over the road transport testing are a very inexpensive solution for production floor testing.

**TABLE MODEL US-RD**  
(24" x 24" x 36" High)

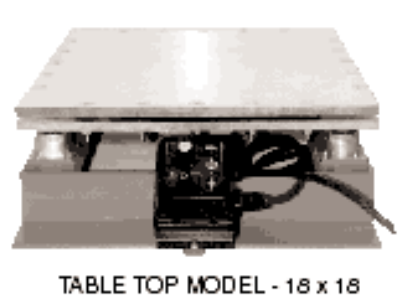
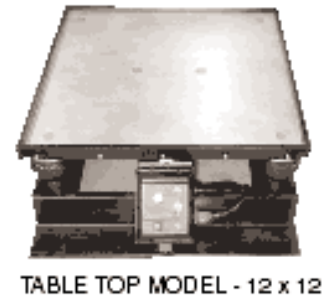



# Platform Tables

## LOW PROFILE

DRUM PACKER

Low profile drum packer 3" off floor - Model SC R-DP

Heavy steel top for long wear

Adjustable speed & force 115 volt heavy duty vibrator

Runner to secure to floor

Adjustable brackets for drums or boxes

Shock absorber to eliminate vibration transfer

**VIBCO's popular Drum Packer has adjustable force and speed vibrator to handle a variety of materials. 115 volt makes it easy to move where needed and plugs into any available 115 volt outlet.**

**VIBCO's low profile Platform Tables on or off floor scales for packing gaylords, boxes, or crates on pallets up to 48-54".**

GAYLORD PACKER

Gaylord packing table with rails for wood skid 6" off floor

# Grid Top Tables

**GRID TABLE ONLY - FIT IN WITH EXISTING ROLLER CONVEYOR**

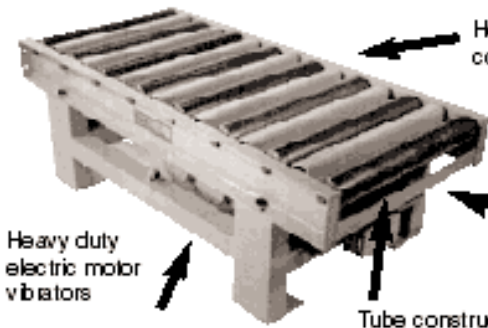

**GRID WITH CONVEYOR**

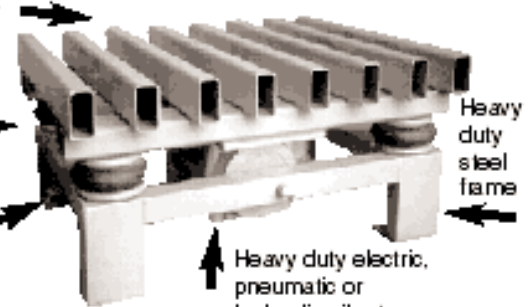

**VIBCO's Grid Top Tables solve many filling, packing and weighing problems. Most common is the standard Grid Top Table with vibrators underneath. Below are other VIBCO solutions for weigh scale applications and vibrator placements.**

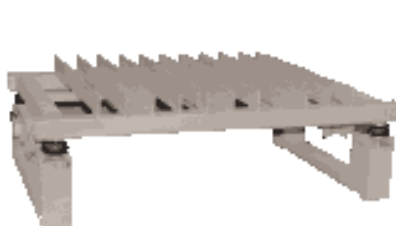

Grid table straddling high floor scale

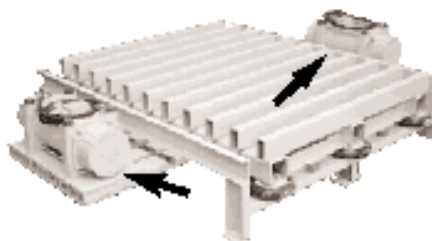

Low profile with outboard vibrators straddling scale

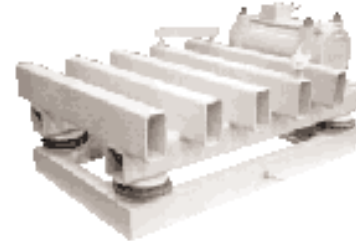

Drum packer in roller conveyor line

# Railroad Carshakers

**ROTARY PISTON  
CCW-5000**

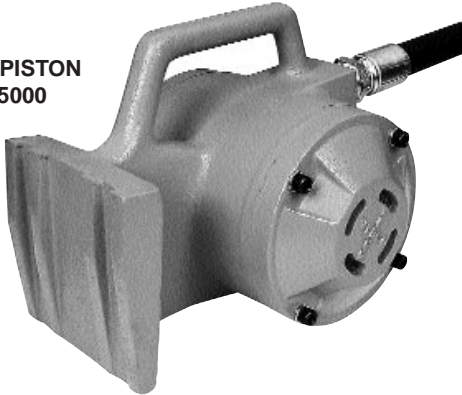

**ROTARY ROLLER  
SVRWS-5500,  
SVRWS-6500**



## FEATURES:

- **PORTABLE • POWERFUL • QUIET • RUGGED • RELIABLE**
- **QUICK MOUNT! Clamp-on or Wedge • SAFE • LOW COST**
- **LOW MAINTENANCE**

## YOUR BEST CHOICE . . .

### ROTARY PISTON - CCW-5000

Your best choice of all pneumatic railroad carshakers. This patented unit developed by VIBCO accomplishes 3 vital functions:

1. It will empty the most stubborn materials.
2. It is silent, no more sound than an electric motor. (72-75 dB)
3. Low air consumption compared to other pneumatic units.

Other features are: No lubrication needed: Can easily be repaired by maintenance department.

### HIGH FREQUENCY AIR - SVRWS

Your second best choice for railroad carshakers, these units will move the most stubborn materials. The silent SVRWS (80-85 dB) with wedge head comes in 2 sizes, SVRWS-5500 and 6500.

Virtually no material can stand up to the high force and 10000 VPM (vibrations per minute) these units create.

The high frequency units can also be supplied with clamp-on brackets, SVRC-5500, 6500 & 8000.

For more information see Catalog #9126.

### PISTON AIR

Model 44 carshaker has wedge bracket to fit car's female Dove-tail receptacle. Available in powerful 3" bore sizes to help evacuate hopper cars quickly.

The lightweight, ease of portability, low cost and high forces of Model 44 carshaker has proven highly desirable for the small to medium consumer. See page 18 for technical data under 3" piston vibrators.

### BIG BUSTER

Big Buster carshakers provide high force at low frequency. The smaller units are supplied with wedge bracket PFW-1500, and with built-in clamp-on bracket as PC-3500 and PC-8000. For more information, see page 21 & 22.

### ELECTRIC

The VIBCO electric carshakers use the heavy duty line electric - 2P vibrators with their heavy duty reliability and performance. Single phase operation offered up to model 2P-800, three phase in all models. Wedge bracket to fit female receptacle on railroad car offered up to model 2P-800; clamp-on bracket available for all models. All models have overload protection and adjustable eccentrics providing flexibility to meet changes brought about by changes brought about by changes in density of car contents. See page 25-28 for technical data.



Ask for Catalog #9126

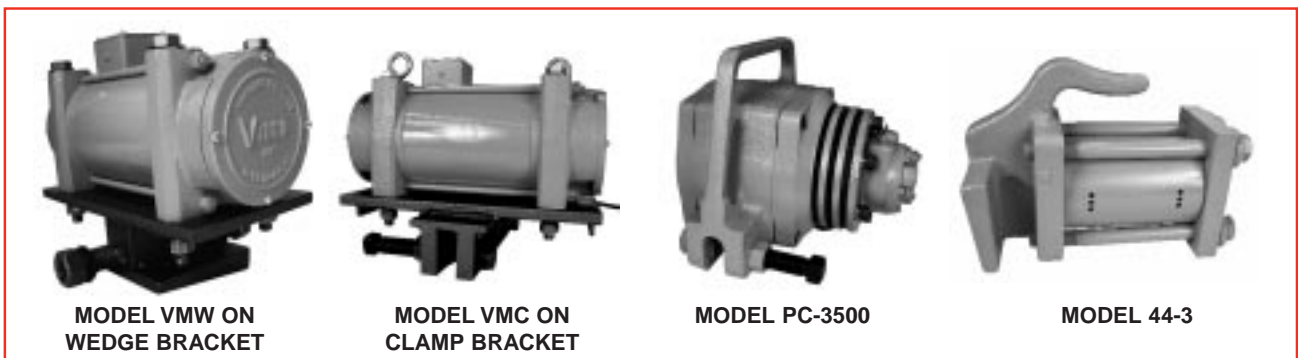

**MODEL VMW ON  
WEDGE BRACKET**

**MODEL VMC ON  
CLAMP BRACKET**

**MODEL PC-3500**

**MODEL 44-3**

# Unload Railroad Hopper Cars Faster & Cleaner with Less Labor . . .

## SIMPLE RULES FOR SELECTING YOUR CARSHAKER

MATERIAL IN R.R. CAR	
<b>GROUP 1</b>	Cement, flour, carbon black, bone black, aluminum shot.
<b>GROUP 2</b>	"After" Vibration (for cleaning car) Cement, sugar, flour, chemical salts (no moisture), corn grits, arsenic, barley hops, carbon black, borax, fluoride, gypsum, sodic sulphate, peanuts, sodium nitrate, semolina, tri-sodium phosphate and the like materials.
<b>GROUP 3</b>	Salts, molasses, iron ore, malt (if sticky) potash, bauxite, calcium carbide, crushed marble, and the like materials.
<b>GROUP 4</b>	Sand, stone, asphalt, stone dust, fly-ash, salt, coal, clay-lime-lumps, and the like materials.

### ELECTRICALLY OPERATED

Model	Consisting of		Electric* Power	Weight Lbs.	Used For Group	dB**
	Vibrator	Bracket*****				
VMC-450	2P-450***	Clamp-On	1 & 3 Phase	50	1	70
VMC-1000	4P-1000****	Clamp-On	1 & 3 Phase	52	1	70
VMW-450	2P-450	Wedge	1 & 3 Phase	48	1	70
VMW-700, 1000	4P-700, 4P-1000	Wedge	1 & 3 Phase	50	1	70
VMC-800	2P-800	Clamp-On	1 & 3 Phase	85	2	75
VMW-800	2P-800	Wedge	1 & 3 Phase	75	2	75
VMC-1700	2P-1700	Clamp-On	3 Phase	90	3	78
VMC-2500	2P-2500	Clamp-On	3 Phase	98	4	80

### AIR OPERATED

Model	Vibrator	Bracket	CFM/80 PSI	Lbs.	Group	dB**
CCW-5000	Rotary Piston	Wedge	35	48	1-2	72-75
44-3	3" Piston	Wedge	30	50	1-2	93-95
CCW-5000	Rotary Piston	Wedge	35	48	2-3	72-75
PFW-1500	PF-1500	Wedge	21	55	1-2	80-85
PFC-1500	PF-1500	Clamp-On	21	63	1-2	80-85
CCW-5000	Rotary Piston	Wedge	35	48	2-3	72-75
SVRWS-5500, 6500	High-Frequency	Wedge	50	48	2-3	78-85
44-4	3" L-Piston	Wedge	50	60	2-3	90-95
PC-3500	PC-3500	Clamp-On	39	70	2-3	80-85
SVRWS-5500 and 6500	SVRS-Silent High Frequency	Wedge	50	48	3-4	78-85
PC-3500	PC-3500	Clamp-On	39	51	3-4	80-85
SVRC-5500, 6500 and 8000	SVR-High Frequency	Clamp-On	55	58	3-4	93-95

\*115 or 230 volt 1 phase; 230, 460, 575 volt 3 phase.

\*\*Decibel at 1 meter on A-scale.

\*\*\*2P-450 for fine to granular materials

\*\*\*\*4P-1000 for lumpy or stringy materials

\*\*\*\*\*When possible use wedge bracket over clamp-on for better vibration transfer

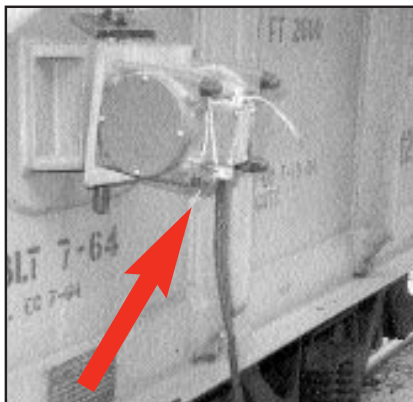

VMW 450 in flour car wedge.

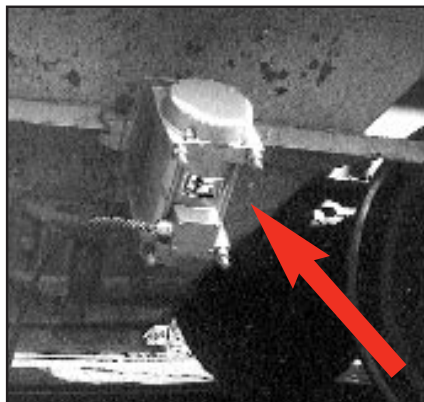

VMC-800 on hopper pocket.

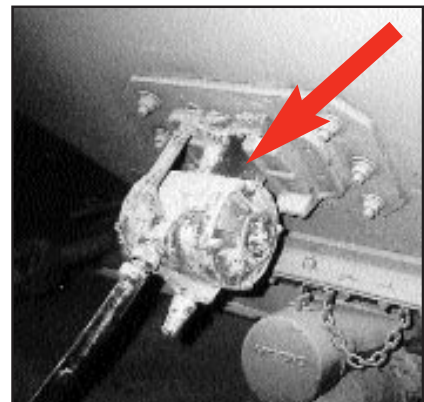

CCW-5000 on railroad hopper car.

# Air Cannons



Ask for  
Catalog #9131

- **NEW  
REVOLUTIONARY  
DESIGN**
- **NO CLOGGING OR  
STICKING VALVE**
- **MAINTENANCE  
FREE**
- **SAFE**
- **NOISELESS**

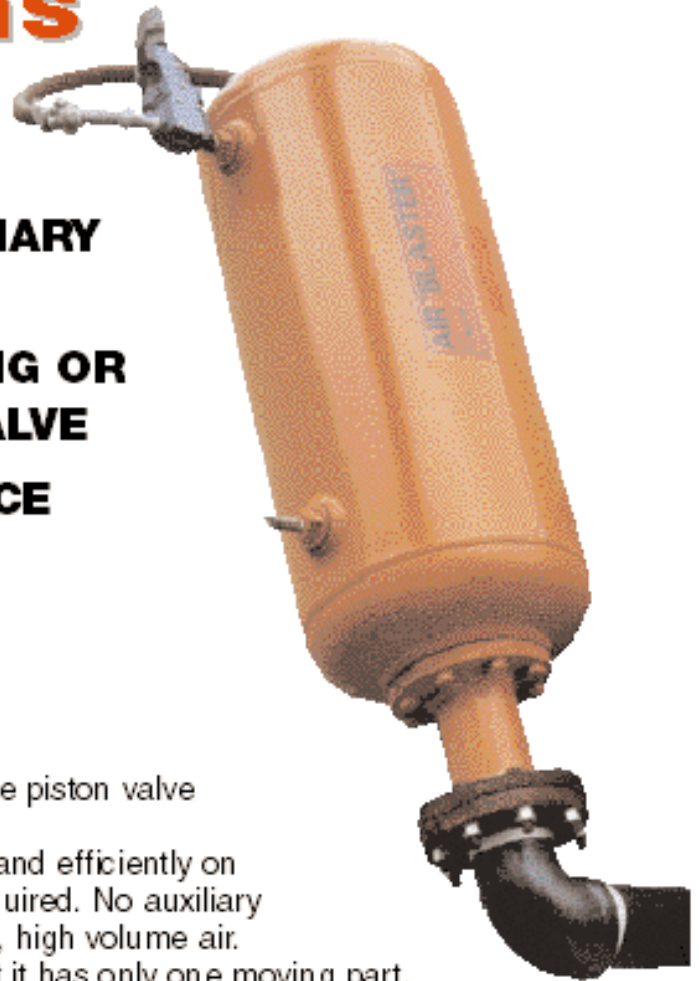

**VIBCO'S AIR CANNON** uses a new double piston valve concept to solve material flow problems.

The **VIBCO AIR CANNON** will work safely and efficiently on normal plant air. 80 to 125 PSI is all that is required. No auxiliary compressors needed to provide high pressure, high volume air.

The **VIBCO AIR CANNON** is so simple that it has only one moving part.

The **VIBCO AIR CANNON** will work safely and efficiently in any position, on any bin - thick concrete or light gauge steel - on any material from wood chips, pellets, chemicals, clay, cattle feed, stringy materials and many others.

## HOW IT WORKS

The **VIBCO AIR CANNON** or **AIR BLASTER** consists of a high pressure tank storing compressed air (80-125 PSI) and a quick release piston valve which instantaneously on command releases the compressed air into the bin or silo.

It is the new and simple double piston design that makes the big difference. There are no close tolerances or O-rings as in other competitive air blasters using a close tolerance piston with O-rings as a valve. The pistons in these swell and stick due to atmospheric change. After the blast the backlash may suck some of the bin material into the valve which also can cause the piston to stick. The O-rings due to lack of lubrication, can also stick or dry out, losing their sealing capability.

The **VIBCO DOUBLE PISTON** has a double piston that fits loosely in the cylinder - no tight tolerance fit. The air pressure behind the piston forces it against the valve seat where it attains a perfect seal. No O-rings are needed. It cannot jam, clog or stick, even if foreign material enters the valve.

When the three-way valve (manual or solenoid) is activated, the high pressure air in the filling line is released to atmosphere. The piston is both sucked away from its seat by the sudden pressure drop as well as pushed back by the high air pressure in the tank. This allows the high pressure air in the tank to "Blast" out through the discharge pipe into the material, breaking it loose. When the pressure in the tank has been released, the piston (due to force of gravity) falls down closing the outlet preventing a "backlash" and bin material from entering the valve and tank.

# VIBCO'S AIR CANNONS ON THE JOB

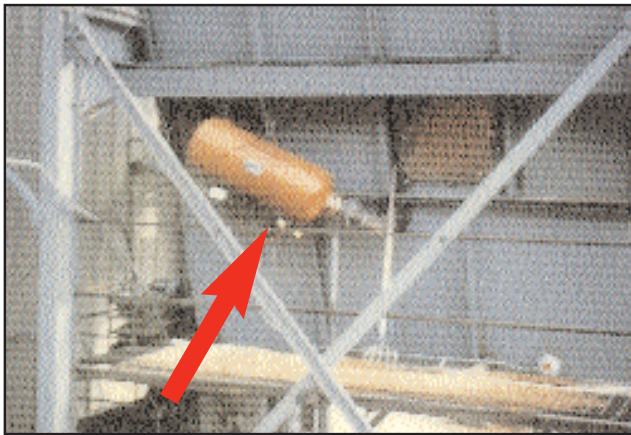

**TWO ABS-4-5 AIR CANNONS ON FEED BIN:** Company used cannons to maintain a continuous feed of bark and wood chips to fire boiler. No bridging or packing over screw conveyors occurred.

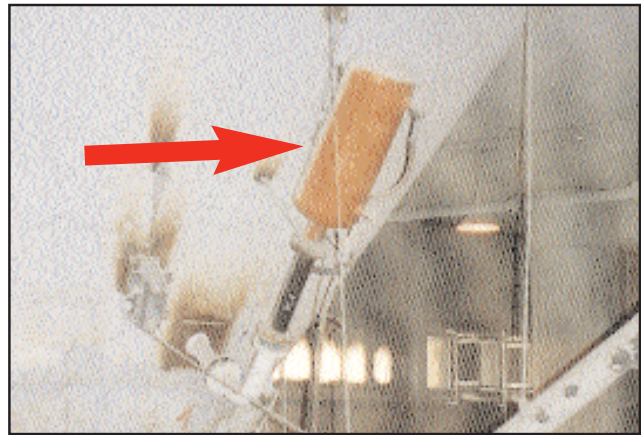

**ABS-4-5 AIR CANNON ON CEMENT SILO:** Long pipe was used to eliminate aerated cement from backing up in discharge pipe.

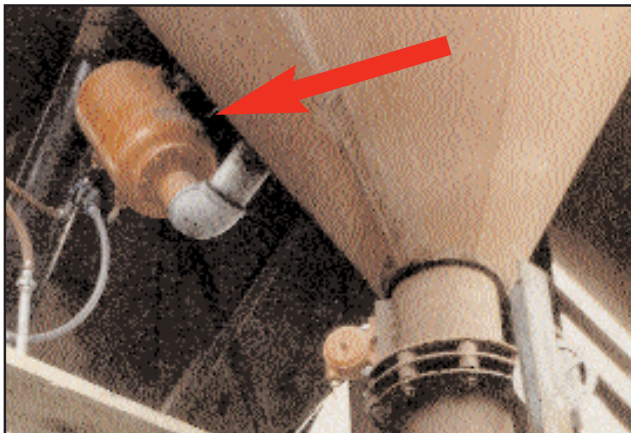

**AIR CANNON & AIR VIBRATOR COMBO:** Air Cannon moves material to feed chute where VS-320 air turbine keeps material moving.

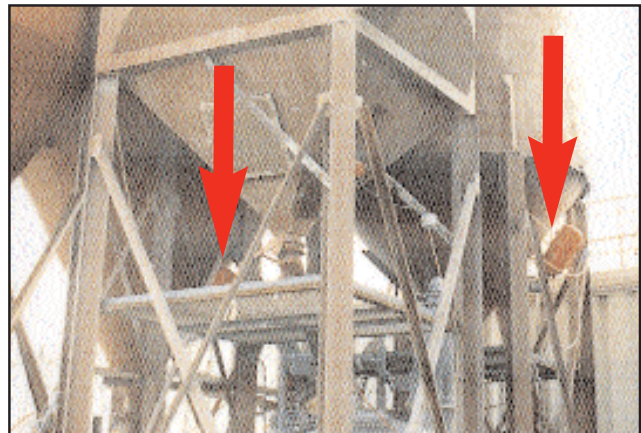

**ABS-4-2 ON WHEAT GLUTEN BIN:** Material would cake up making discharge impossible. Continuous aeration eliminated this problem.

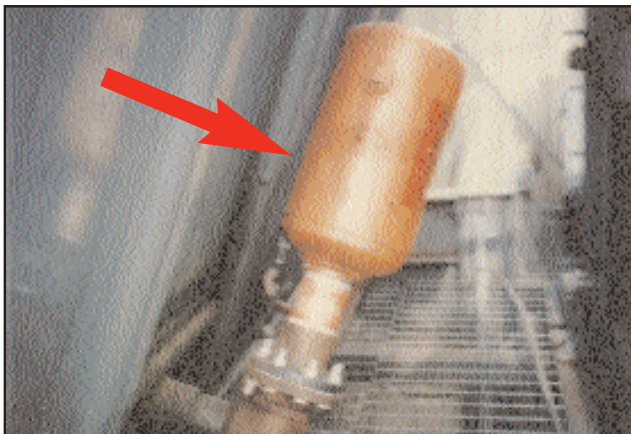

**HOGGED FUEL BIN HAS 4 ABS-4-5:** Lumber company installed air cannons to move the hogged fuel to the internal agitators reducing boiler down time.

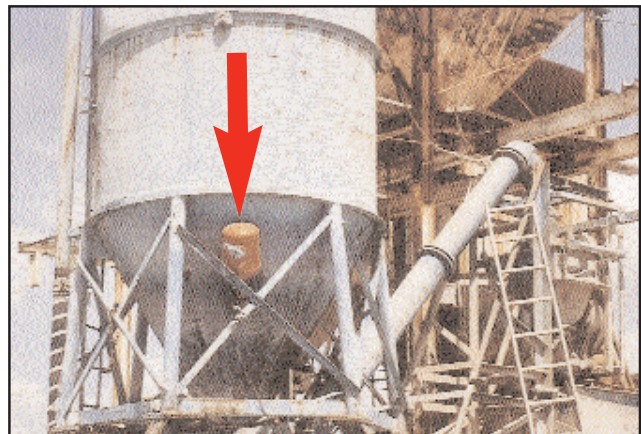

**ABS-2 ON CEMENT HOPPER:** Continuous blasting kept cement aerated and free flowing.

# More VIBCO VIBRATORS IN ACTION



**VS-320 SILENT TURBINE VIBRATOR ON PAINT SLURRY** reduced surface tension and increased product flow significantly so paint no longer built up on slurry.



**MLTSS-130 STAINLESS STEEL TURBINE VIBRATOR ON TRANSITION CONE FEEDER** keeps baby carrots from clogging feeder cone and meets sanitary requirements for food processing application.

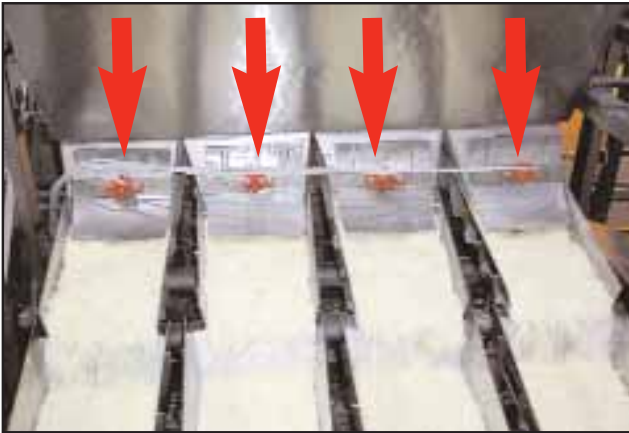

**BVS-190 SILENT TURBINE VIBRATORS ON CHEESE HOPPERS** helped with material flow and increased daily production levels.



**BVS-320 SILENT TURBINE VIBRATOR ON MOBILE BIN** reduced batch contamination issues and clean up time. daily production increased significantly.



**VS-510 SILENT TURBINE VIBRATOR ON CONCRETE SCREED** eliminated blemishes from ball vibrator lubricant leaks and reduced noise levels significantly.



**BBS-130 SILENT TURBINE VIBRATOR ON BOWL FEEDER** reduced noise to acceptable level and kept product contaminant-free because no lubrication needed.

# More VIBCO VIBRATORS IN ACTION



**BVS-130 SILENT TURBINE VIBRATOR ON CHUTE** produces a smooth flow of ball bearings to the feeder tray below.



**BVS-570 SILENT TURBINE VIBRATOR ON REACTOR WITH HEAT MOUNT** keeps lead oxide from building up on the cover. Three tier special mount keeps vibrators from the heat and operating in critical application.



**BVS-250 SILENT TURBINE VIBRATOR ON FILLING STATION** increased fill rates and daily production by eliminating clogging of chutes.



**FBS-160 SILENT TURBINE VIBRATOR ON LOADING SPOUT** reduced noise levels and increased employee productivity. More installations planned!



**VS-100 SILENT TURBINE VIBRATOR ON BELT FEEDER** keeps vaccine bottles in line so they feed through the lane reduction without getting stuck or breaking.



**CCF-2000 SILENT TURBINE VIBRATOR ON FEEDER TUBE** increased material flow and keeps it consistent. No more lost man hours to manual unclogging.

# Engineering Data & Applications

## TYPICAL VIBRATOR MOUNTING

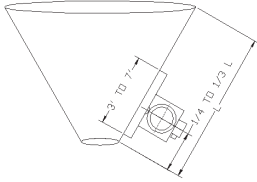

### 1. CONICAL HOPPERS:

Mount vibrator (by channel-iron stiffener 3'-7' long\*) to hopper wall from 1/4 to 1/3 the distance from the discharge to the top. Should a second vibrator be necessary, it should be mounted diametrically opposite and approximately 1/2 up the wall.

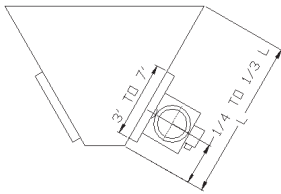

### 2. RECTANGULAR HOPPERS:

Mount as for conical hoppers on the centerline of one side. A second vibrator may be required if complete cleaning of all corners and sides is desired. Mount as per paragraph 1.

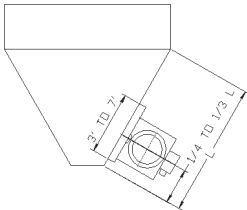

### 3. RECTANGULAR BINS WITH HOPPER BOTTOMS:

Usually requires larger force vibrators (than above) because of additional "head" load of material. Locate vibrator 1/4 to 1/3 distance up sloping section and mount as in paragraphs 1 & 2.

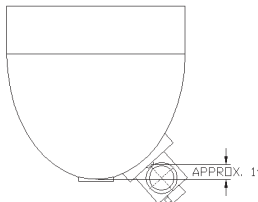

### 4. PARABOLIC BINS OR HOPPERS:

Mount vibrator within 1-foot of each discharge opening and in line with center of opening.

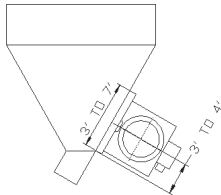

### 5. BINS WITH SLOPING CHUTE DISCHARGE:

Vibrator is mounted 1/8 to 1/6 distance up bin wall that is contiguous with under side of chute. This lower mounting position puts vibrator close to bin discharge throat and assures vibration transference into chute.

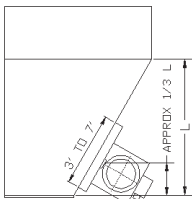

### 6. BIN OR HOPPER WITH VERTICAL SIDE:

Mount vibrator on wall with least slope in similar manner as in paragraph 3.

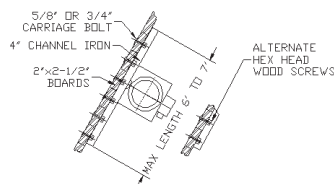

\*For instruction on stiffening of bins and mounting procedures ask for Vibrator Mounting Instructions.

NOTE: for other applications not covered here please consult factory for recommendations. This is a free service and without obligation to you.



# How to Select the Proper Vibrator in Three Easy Steps

- 1. DETERMINE NEEDED VIBRATOR FORCE FOR YOUR APPLICATION**
- 2. FIND AVAILABLE VIBRATOR MODELS**
- 3. SELECT ELECTRIC, PNEUMATIC OR HYDRAULIC OPERATION.**

## **1. DETERMINE NEEDED VIBRATOR CENTRIFUGAL FORCE (IMPACT) FOR YOUR APPLICATION**

---

### **A. BINS, HOPPERS**

To move the material in a bin or hopper, the friction between the material and the bin skin has to be broken. Once this is done the material cannot cling to the bin sides and it will flow out through the discharge. The vibrator force needed to accomplish this, is for 80% of all applications, very simply calculated as follows:

Calculate the weight of the material in the transition or sloping part of the bin. Normally this is the only place where the friction between the material and the bin sides has to be broken. **DO NOT CALCULATE THE TOTAL WEIGHT, ONLY WHAT IS IN THE TRANSITION PART.**

For CONICAL BINS, calculate as follows:  $.261 \times \text{dia.}^2 \times \text{height} \times \text{material density in lbs/cu. ft.}$

For RECTANGULAR BINS,  $\text{length} \times \text{width} \times \text{height} \times 1/3 \times \text{material density.}$

When the weight has been calculated, divide by 10. The figure you get is the force or impact needed on your vibrator \_\_\_\_\_ lbs. Continue with paragraph B.

For example: The conical part of a 25 ton bin contains 7000 lbs. Divide 7000 by 10, you need a vibrator with 700 lbs. of centrifugal force or impact. Find suitable vibrator under Paragraph B.

NOTE: Additional considerations when sizing vibrator to bins.

1. If bin side angle is below 30°, select next larger vibrator.
  2. If bin thickness is extra heavy (see table under section B), select next larger vibrator.
  3. On real sticky and hard to move materials, it is better to use two (2) small vibrators instead of a large one (find the smaller one by figuring half the material weight.)
- 

### **B. VIBRATING TABLES**

#### **1. PACKING MATERIAL**

Dense materials respond best to high frequency vibration (3600 RPM or more) while light, fluffy or flaky materials respond best to low frequency vibration (1800 RPM or less).

For packing or settling materials, use a vibrator with an impact force of (1.5) to 2 times larger than the weight of the material plus container. Find suitable vibrator under Paragraph 2.

---

### **C. VIBRATING SCREENS**

Rule of Thumb: for self-cleaning screen use a vibrator with a centrifugal force (impact) four (4) times the weight of the material plus the weight of the screen.

NOTE: Coarse and lumpy materials respond best to 3600 VPM (vibrations per minute), powdery and dry materials, 1800 VPM, sticky and wet materials, over 3600 VPM.

---

### **D. CONSOLIDATING CONCRETE**

Rule of Thumb: For 3" "slump" concrete use a vibrator with the same force (impact) as the weight of concrete and form. For 1-2" slump concrete, an additional 30-50% impact is needed. For dry mixes (0-slump) add 100-200%.

NOTE: FOR ADDITIONAL SIZING INFORMATION, SEE PAGES 35 & 36 for suitable bracketry. Find suitable vibrator under paragraph B. Ask for Bulletin 0103 and 8401.

---

**E. RAILROAD CARSHAKERS:** SIZING, SEE PAGE 41 & 42.

---

**F. MATCH PLATE - FOUNDRY:** SIZING, SEE PAGE 11, 13 & 17.

---

**G. FOR SPECIAL APPLICATIONS AND QUESTIONS CONTACT VIBCO FOR FREE RECOMMENDATION.**

---

# VIBRATOR SELECTION CONT.

## 2. FIND AVAILABLE VIBRATOR MODELS

From the table below, draw a line across from the force calculated in paragraph A. You will find you have a choice of several vibrators, both electric, pneumatic and hydraulic models. List them below and continue with Paragraph C.

MODEL: \_\_\_\_\_

To continue with the example - 700 lbs. of vibrator force is needed. Draw a line straight across from 700 lbs. The line will cross the force ranges of suitable vibrators: Electric Models 2P-450; 2P-800; 4P-700; 4P-1000; US-900; SCR-1000; and Pneumatic Models BVS & VS-380; BV & V-380; 50-2L; 50-2LS; PF-800. Now continue with Paragraph C to make final selection.

Vibrator Force or Impact Lbs.	ELECTRIC MODELS										PNEUMATIC MODELS										HYDRAULIC MODELS			BIN SKIN Thickness Max.							
	PAGE NO.		4P Page 24-28		6P Page 24-28		8P Page 24-28		SPR Page 29-30		US Page 31-32		SFC Page 34		FC Page 34		SCR Page 23-24		TURBINE Page 3-12		BALL Page 13-14		PISTON Page 15-18		SVR Page 19-20		BIG BUSTER Page 21-22		TURBINE Page 21-22		
10																															20 Ga.
20																															20 Ga.
40																															1/16
60																															1/8
80																															3/16
100																															1/4
150																															5/16
200																															5/16
300																															3/8
400																															3/8
500																															7/16
600																															7/16
700																															1/2
800																															1/2
900																															1/2
1000																															1/2
1200																															1/2
1400																															3/4
1600																															3/4
2000																															3/4
2500																															3/4
3000																															1
3500																															1
4000																															1-1/4
4500																															1-1/4
5000																															1-1/4
6000																															1-1/4
7000																															1-1/4
8000																															1-1/4

# VIBRATOR SELECTION CONT.

## 3. SELECT ELECTRIC, PNEUMATIC or HYDRAULIC OPERATION

### ELECTRIC VIBRATOR MODEL SELECTOR

ELECTRICAL DATA	MODEL								
	2P	4P	6P	8P	SPR	US	SFC	FC	SCR
115 volt 1 phase	X	X	X	X	X	X	X	X	X
230 volt 1 phase	X	X	X	X	X		X	X	X
Any voltage 3 phase	X	X	X	X			X	X	
50 cycles	X	X	X	X	X	X	X	X	X
Continuous duty	X	X	X	X	X		X	X	X
Intermittent duty						X			
More than 20 stops & starts per hr. 3 phase	X	X	X	X			X	X	
More than 20 stops & starts per hr. 1 phase	Z	Z	Z	Z	X	X	Z	Z	
Totally enclosed	X	X	X	X	Z	Z	X	X	X
Outside Fan Cooled							Z	X	
Open construction					Z	Z			
Built in overload protection 1 phase	X	X	X	X	X	X	X	X	X
Adjustable speed					Z	X			X
Adjustable eccentric	X	X	X	X	Z	X	X	X	X
Decibel at 3' on A scale	60	60	60	60	48	90	62	62	65
<b>APPLICATION</b>									
Outside	X	X	X	X	X	X	X	X	X
Water splash	X	X	X	X	Z	Z	X	X	X
Powder in air dry	X	X	X	X	Z	Z	Z	Z	X
Powder in air sticky	X	X	X	X		Z			Z
Powder in air metallic	X	X	X	X		Z			Z
High temperature	Z	Z	Z	Z			Z	X	
Bins with coarse mtr.					X	X	X	X	X
Bins with tine mtr.	X				X	X	X	X	X
Bins lumpy or sticky mtr.		X	X						
Bins with stringy mtr.		X	X	X					
Bins powdery & sticky mtr.						X			
Packing coarse mtr.	X						X	X	X
Packing fine mtr.		X	X	X					X
Stringy-fluffy mtr.			X	X					
Concrete	X					X			
Screens		X	X	X					X
Feeder - chutes	X	X	X	X			X	X	X

Z - SEE BULLETIN COVERING THE MODEL LINE (or consult VIBCO)

### PNEUMATIC VIBRATOR MODEL SELECTION

	PNEUMATIC					
	Turbine	Ball	Piston	SVR	SVRS	Big Buster
Decibel at 3' on A scale*	72.78	85-95	90-95	95-105	80-85	80-90
Air consumption**	2	3	1	6	5	4
Repair Cost**	1	3	2	4	5	6
Maintenance Cost*	1	3	2	4	5	6
Purchasing Cost	2	3	1	4	5	6
Patented Design	X			X	X	X
Lubrication Required		X	X	X	X	X
No lubrication required	X					
Requires clean air			X	X	X	X
Tapped exhaust for leading away exhaust air	X	X	X		Z	X
High temp.		X				
Steam -pressure cleaning	X	X		X		
Concrete application	X			X	X	

\*AVERAGE READING \*\*LOWEST NUMBER BEST

Example: Piston lowest in air consumption, then Turbine, Ball, Big Buster, SCRS & SVR

### GENERAL COMMENTS:

In general, electric vibrators are initially higher in cost than pneumatic vibrators; however, the operation cost is considerably less and the difference in price and installation cost is recaptured in a few months of operation. The electric units have the lowest noise readings, 60-70 dB, no more sound than an electric motor. The life expectancy is 2-3 times that of an air operated unit. The life of an air operated unit is, to a great extent, determined by the cleanness of the compressed air and the operating pressure. Maximum operating pressure is 80 PSI, above 80 PSI, the life of the pneumatic vibrator diminishes rapidly. The dBa reading on piston vibrators is 80-110, on ball vibrators, 80-115. The ONLY pneumatic units with a dBa reading of 60-80 are the TURBINE VIBRATORS. The least air consuming are the piston vibrators, then the turbine, ball and SVR high frequency vibrators. As a general rule: for standard applications, limit your selection of vibrators to the SCR Electric Vibrator Line and the Turbine Pneumatic Vibrators. They will give you the latest in vibration technology and design with the lowest noise, the best life, the least maintenance, and the lowest energy consumption.

The hydraulic vibrators are fast gaining acceptance but still primarily used on OEM equipment for food and related products.

For additional selection considerations, see table for electric vibrators and pneumatic vibrators located on this page. Also look up the pages for each specific vibrator for additional information.

To continue with our example: Choose electric model 2P-450 or 2P-800 if bin contains fine granular material (see also page 25-28); 4P-700 or 4P-1000 if bin contains lumpy or stringy material (page 25-28); US-900 if bin contains light powdery or real sticky material (cement, concrete, molasses, etc., page 31-32; SCR-1000 (page 23-24) when different materials are used in the bin and different frequencies or forces are needed. For additional considerations, also see "Electric Vibrator Model Selection" table on this page.

When choosing a pneumatic vibrator, see table on this page "Pneumatic Vibrator Model Selection". The turbine BVS and VS-380 (page 3-12) is noiseless, meets OSHA, has low maintenance cost, and needs no lubrication. (all other pneumatic vibrators need lubrication).

Difference between BVS and VS: In BVS, the air exhaust is threaded allowing connection of a hose or pipe; permitting the exhaust air to be exhausted outside work area; or used with different mufflers. The VS has a built-in muffler and exhausts the air into the atmosphere where the vibrator is mounted.

Ball vibrators BV-380 or V-380 (page 13-14): Noise level increases rapidly as ball and race wears. Use in high temperature applications. Difference between BV and V is the same as with BVS and VS.

Piston models 50-2L and 50-2LS are used for low cost and low air consumption, must be lubricated. Pistons are preferable on feeders and packing tables. Comes in silent and non-silent models, (page 15-18).

Big Buster, PF-800 is primarily used for railroad car shakers where a high intermittent force is needed (pages 21-22).

# VIBCO OFFERS A WIDE SELECTION OF ELECTRIC,

VIBRATOR FORCE OR IMPACT IN LBS. SEE PAGE 47-50\*

20 40 60 80 100 150 200 300 400 500

## ELECTRIC SMALL IMPACT LINE PAGE 29-30

SPR, SPRT, SPRWT			
20	40	60	80
CE-60			



## SCR ADJUSTABLE SPEED & FORCE PAGE 23-24

SCR-100	SCR-200	SCR-300	350	400	SCR-500
---------	---------	---------	-----	-----	---------

## 2P, 4P HEAVY DUTY LINE PAGE 25-28

2P-75	2P-100	2P-150	2P-200	2P-450
	4P-350		4P-600/700	4P-1000

## SFC & FC PAGE 34

SFC-100	SFC-300, FC-100	FC-300
---------	-----------------	--------

## US-HIGH FREQUENCY LINE DC - 12 VOLT DC BATTERY OPERATED PAGE 31-32

US-100	US-450	
DC-100	DC-450, DC-200, DC-300	DC-500



## PNEUMATIC SILENT TURBINE VIBRATORS PAGE 5-12



BBS, FBS, VS-100, BVS-60	BBS, FBS, VS, BVS-130	VS-BVS-160 BBS-160	VS-BVS-190 BBS-190	VS-BVS-250	VS-BVS-320
--------------------------	-----------------------	-----------------------	-----------------------	------------	------------

## BALL VIBRATORS PAGE 13-14



BB-100, V-100, BV-60	BB, V, BV-130	BB-160	BB, BV, V-190	BV, V-250	BV-320
----------------------	---------------	--------	---------------	-----------	--------

## PISTON VIBRATORS PAGE 15-18



10-5/8	10-3/4	10-1   50, 55-1, 1-1/4S	10-1-1/4   50, 55-1-1/4   50, 55-1-1/2S	50, 55 - 1-1/2	50 - 1-1/2L, LS	50, 55 - 2S	50, 55 - 2
--------	--------	-------------------------	---	----------------	-----------------	-------------	------------

## HIGH FREQUENCY PAGE 19-20

## BIG BUSTER PNEUMATIC PAGE 21-22

## HYDRAULIC PAGE 22

B-190	B-250
-------	-------

\*Follow selected vibrator force line vertically to find vibrators to select from with same force output.

FOR EXAMPLE: I need 560 lbs. of force – draw a vertical line from the 560 Force Output Value. Your choice of vibrators are: Electric Model SCR-1000 with adjustable speed & force; Model 2P-450 heavy duty; Model 4P-1000 - 1800 RPM heavy duty; Model US-700 high frequency; DC-700 12 Volt DC;

# PNEUMATIC, HYDRAULIC VIBRATORS\*

560    600    700    800    900    1000    2000    3000    4000    5000

**NOTE: For additional information on vibrator selection see page 48.**



**SCR-1000**

**2P-100**



**2P-450**

SCR-1000

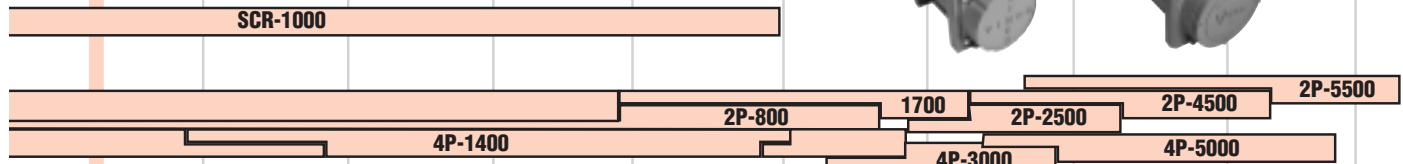

**US-450**

**US-1600**



**BVS-570**



**CCF-5000**



**V-320**

**BV, V-380**

**55-2**

**50-3**

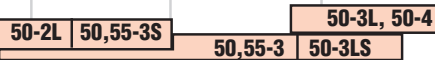
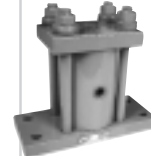

**SVRLS-5500**



**SVRFS-5500**



**PC-3500**

**PF-800**

**PF-1200**

**PF-1500**

**SVR, SVRS**

**4000**

**SVR,S-5500**

**SVR,S-6500**

**PF, PC-3500**



**B-320**

**HLF-700**

**HLF-1300**

**HF-800**

**HF-1200**

**HF-1500**

**HL-3000**

**HC, HF-3500**

**LH-3500**

**LF-700**

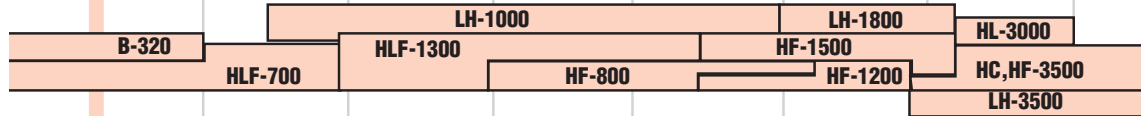

Pneumatic VS or BVS-320 Silent Turbine; V-320 Ball Vibrator; Model 55-2 or 50-2 Piston Vibrator; Model HLF-700 Hydraulic. Which vibrator to choose: First select Electric, Pneumatic or Hydraulic; then see page 50 for further selection data or call an application engineer at VIBCO for advice.

# VIBCO

We're The <sup>SILENT</sup> Vibrator Guys.™

## CONSTRUCTION CATALOGS

### HANDBOOK & EQUIPMENT GUIDE: EXTERNAL CONCRETE VIBRATION

- How-To-Booklet
- 71 Application Photos
- Selection & Locating Guide
- Catalog #8401

### HANDBOOK & EQUIPMENT GUIDE: EXTERNAL VIBRATION OF WALLS & COLUMNS

- How-To-Booklet
- Engineering Data
- Application Photos
- Catalog #0103

### SAND & GRAVEL VIBRATORS

- 60 Application Photos
- Selection & Sizing Guide
- Pneumatic, Electric & Hydraulic
- Catalog #9603

### INTERNAL CONCRETE VIBRATORS

- Electric 1-3/8" to 2-1/2" Head Size
- Pneumatic 1-3/8" to 3"
- Interchangeable head and shaft
- Catalog #9606

### PLATE COMPACTORS & ROLLERS

- 12" to 20" plates
- Reversible and single directional plates
- Rollers 12" and 36" sizes available
- Catalog #9606

### GENERAL CATALOG

- Pneumatic Vibrators
- Electric Vibrators
- Hydraulic Vibrators
- Catalog #9001

### BIG BERTHA DUMP BODY VIBRATOR

- Dump Body Vibrators
- How To Select Guide
- Drawings & Dimensions
- Catalog #0101

### DC VIBRATORS 12 & 24 VOLT

- Dump Body Vibrators
- Salt & sand spreaders, etc.
- 20 to 3500 lbs. force
- Catalog #9112

### BIG BERTHA DUMP BODY VIBRATORS 12 VOLT DC

- Dump Body Vibrators
- Application Photos
- Selection & Sizing Guide
- Catalog #9511

### CONCRETE PUMP VIBRATOR

- Model DC 500 (The Bulldog)
- Pneumatic, Hydraulic, & Electric
- Electric 12 & 24 Volt DC
- Catalog #9702

# VIBCO

## INDUSTRIAL CATALOGS

We're The <sup>SILENT</sup> Vibrator Guys.™

### GENERAL CATALOG

- Pneumatic Vibrators
- Electric Vibrators
- Hydraulic Vibrators
- Catalog #9001

### PNEUMATIC TURBINE VIBRATORS

- Silent Operation
- No Lubrication
- Longer Service Life
- Catalog #9127

### ELECTRIC VIBRATORS ADJUSTABLE SPEED & FORCE

- Adjustable Speed & Force
- Silent Operation
- Low Power Consumption
- Catalog #0104

### RAILROAD CARSHAKER VIBRATORS

- Largest Line, Light and Portable
- Electric, Pneumatic or Hydraulic
- Silent Models
- Catalog #9126

### AIR CANNONS

- Patented Dual Piston Design
- Uses Normal Plant Air
- Install in Any Position
- Catalog #9131

### VIBRATORS FOR PLATING TANKS

- Specifically Designed for Printed Circuit Industry
- Electric & Pneumatic Models
- Application Photos
- Catalog #9709

### EZ SOURCE QUICK REFERENCE VIBRATOR CATALOG

- EZ Source Quick Reference Guide
- General Product Selection Guide
- Drawings & Dimensions
- Catalog #0102

### VIBRATING TABLES

- Densify and Compact Materials in Bags, Cartons, etc.
- Fatigue & Quality Control Testing
- Custom Table Designs
- Catalog #7902

### PNEUMATIC BALL VIBRATORS

- Complete line
- Built-in muffler
- Easy maintenance
- Catalog #9703

### PNEUMATIC PISTON VIBRATORS

- Lowest in Air Consumption
- Front or Side Inlet Available
- Drawings & Dimensions
- Catalog #2007



CORPORATE HEADQUARTERS - Wyoming, RI

**CORPORATE HEADQUARTERS & FACTORY:**

75 Stilson Road, P.O. Box 8, Wyoming, RI 02898

Phone: (401) 539-2392 • (800) 633-0032 • FAX: (401) 539-2584

**WESTERN US:**

Phoenix, Arizona 85254

Phone: (480) 596-1809 • (800) 633-0032 • FAX: (480) 596-1614

**CANADA:**

2215 Dunwin Drive, Mississauga, ONT L5L 1X1

Phone: (905) 828-4191 • (800) 465-9709 • FAX: (905) 828-5015

**WEB & E-MAIL:**

E-Mail: [vibrators@vibco.com](mailto:vibrators@vibco.com) • [www.vibco.com](http://www.vibco.com)



Canadian Offices